

Ventile Metall

Messing, Edelstahl, Stahl

Vannes en métal

Laiton, acier inoxydable,
acier

Valves in metal

Brass, stainless steel, steel



Seite/Page/Page

Seite/Page/Page

Seite/Page/Page

**Ventile Messing M
Vannes laiton M
Valves brass M**

Schwenkverschraubung
Coude banjo
Single banjo

471-472



SO 47724

Kegelrückschlagventil
Soupape de retenue à siège conique
Taper seat non-return valve

488-490



SO CV 03A21

Regulierventil
Robinet de réglage
Regulating valve

453-455



SO NV 41A21

Mini-Kugelhahn
Mini robinet à bille
Mini-Ball valve

473-475



SO BV 48A00

Kugelhahn voller Durchgang
Robinet à bille avec passage total
Ball valve with full flow

491



SO BV 08C00

Feinregulierventil
Robinet de réglage fin
Fine regulating valve

456



SO NV 41C21

**Ventile Messing G
Vannes laiton G
Valves brass G**

Durchgangshahn
Robinet simple à passage direct
Total-flow cock

492-493



SO PV 08E01

Regulier-Eckventil
Robinet-équerre de réglage
Elbow regulating valve

457-461



SO NV 41A21E

Regulierventil
Robinet de réglage
Regulating valve

478-480



SO NV 01A21

**Ventile Edelstahl
Vannes acier inoxydable
Valves stainless steel**

Feinregulier-Eckventil
Robinet-équerre de réglage fin
Elbow fine regulating valve

462-464



SO NV 41C21E

Feinregulierventil
Robinet de réglage fin
Fine regulating valve

481



SO NV 01C21

Regulierventil
Robinet de réglage
Regulating valve

496-498



SO NV 51A00

Kegelrückschlagventil
Soupape de retenue à siège conique
Taper seat non-return valve

467-468



SO CV 43A21

Regulier-Eckventil
Robinet-équerre de réglage
Elbow regulating valve

484-485



SO NV 01A21E

Feinregulierventil
Robinet de réglage fin
Fine regulating valve

499



SO NV 51C00

Doppelkugelrückschlagventil
Soupape de retenue à deux billes
Double ball valve

469



SO CV 43B01

Feinregulier-Eckventil
Robinet-équerre de réglage fin
Elbow fine regulating valve

486



SO NV 01C21E

Regulier-Eckventil
Robinet-équerre de réglage
Elbow regulating valve

500-503



SO NV 51A21E

Doppelschutzventil
Vanne à double protection
Double action valve

470



SO CV 43C21

Dosier-Eckventil
Robinet-équerre de réglage de précision
Metering elbow valve

487



SO NV 01D21E

Feinregulier-Eckventil
Robinet-équerre de réglage fin
Elbow fine regulating valve

504-505



SO NV 51C21E

Seite/Page/Page

Seite/Page/Page

Kegelrückschlagventil
Soupape de retenue à siège conique
Taper seat non-return valve



SO CV 53B21

Ventile Zubehör
Vannes accessories
Valves accessories

Kugelhahn
Robinet à bille
Ball valve



SO BV 58A00

Anschraubfuss
Support de fixation
Flange mount

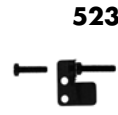

SO 09900

Nadelventil
Robinet à pointeau
Needle valve



SO NV 51B00

Ventilschilder (Satz)
Plaques indicatrices (set)
Valve labels (set)



VSD SO NV

Ventile Edelstahl L
Vannes acier inoxydable L
Valves stainless steel L

2-Weg Hochdruckkugelhahn SOL
Robinet à bille SOL pour haute pression
2-way high pressure ball valve SOL



SOL BV 58A21

Kegelrückschlagventil
Soupape de retenue à siège conique
Taper seat non-return valve



SOL CV 53B21

Ventile Stahl
Vannes acier
Valves steel







Kegelrückschlagventil
Soupape de retenue à siège conique
Taper seat non-return valve



SO 6611

Ventile Messing M
Vannes laiton M
Valves brass M

Sonderausführungen:
Exécution en option:
Optional Services:

-  Spezialbehandlung für Einsatz mit Sauerstoff
 Traitement spécial pour utilisation sous oxygène
 Special treatment for use with oxygen
-  Spezialbehandlung - silikonfrei
 Traitement spécial - sans silicone
 Special treatment - silicone free
-  Spezialreinigung - entfettet
 Traitement spécial - dégraissé
 Special treatment - degreased
-  Vorbeschichtete Gewinde mit Loctite 5061
 Filetages pré enduits avec Loctite 5061
 Pre-coated threads with Loctite 5061
-  Vorbeschichtete Gewinde PTFE-Band umwickelt
 Filetages pré enduits avec ruban en PTFE
 Pre-coated threads with PTFE-tape
-  Chemisch vernickelt
 Nickelage chimique
 Chemical nickel-plated
-  Messing bleiarml
 Laiton à faible teneur en plomb
 Low-lead brass

Ventile Messing G
Vannes laiton G
Valves brass G

Sonderausführungen:
Exécution en option:
Optional Services:

-  Spezialbehandlung für Einsatz mit Sauerstoff
 Traitement spécial pour utilisation sous oxygène
 Special treatment for use with oxygen
-  Spezialbehandlung - silikonfrei
 Traitement spécial - sans silicone
 Special treatment - silicone free
-  Spezialreinigung - entfettet
 Traitement spécial - dégraissé
 Special treatment - degreased
-  Vorbeschichtete Gewinde mit Loctite 5061
 Filetages pré enduits avec Loctite 5061
 Pre-coated threads with Loctite 5061
-  Vorbeschichtete Gewinde PTFE-Band umwickelt
 Filetages pré enduits avec ruban en PTFE
 Pre-coated threads with PTFE-tape
-  Chemisch vernickelt
 Nickelage chimique
 Chemical nickel-plated
-  Messing bleiarml
 Laiton à faible teneur en plomb
 Low-lead brass

Ventile Edelstahl
Vannes acier inoxydable
Valves stainless steel

Sonderausführungen:
Exécution en option:
Optional Services:

-  Spezialbehandlung für Einsatz mit Sauerstoff
 Traitement spécial pour utilisation sous oxygène
 Special treatment for use with oxygen
-  Spezialbehandlung - silikonfrei
 Traitement spécial - sans silicone
 Special treatment - silicone free
-  Spezialreinigung - entfettet
 Traitement spécial - dégraissé
 Special treatment - degreased
-  Vorbeschichtete Gewinde mit Loctite 5061
 Filetages pré enduits avec Loctite 5061
 Pre-coated threads with Loctite 5061

Ventile Edelstahl L
Vannes acier inoxydable L
Valves stainless steel L

Sonderausführungen:
Exécution en option:
Optional Services:

-  Spezialbehandlung für Einsatz mit Sauerstoff
 Traitement spécial pour utilisation sous oxygène
 Special treatment for use with oxygen
-  Spezialbehandlung - silikonfrei
 Traitement spécial - sans silicone
 Special treatment - silicone free
-  Spezialreinigung - entfettet
 Traitement spécial - dégraissé
 Special treatment - degreased
-  Vorbeschichtete Gewinde mit Loctite 5061
 Filetages pré enduits avec Loctite 5061
 Pre-coated threads with Loctite 5061

Ventile Stahl
Vannes acier
Valves steel

Sonderausführungen:
Exécution en option:
Optional Services:

-  Spezialbehandlung für Einsatz mit Sauerstoff
 Traitement spécial pour utilisation sous oxygène
 Special treatment for use with oxygen
-  Spezialbehandlung - silikonfrei
 Traitement spécial - sans silicone
 Special treatment - silicone free
-  Spezialreinigung - entfettet
 Traitement spécial - dégraissé
 Special treatment - degreased
-  Vorbeschichtete Gewinde mit Loctite 5061
 Filetages pré enduits avec Loctite 5061
 Pre-coated threads with Loctite 5061
-  Vorbeschichtete Gewinde PTFE-Band umwickelt
 Filetages pré enduits avec ruban en PTFE
 Pre-coated threads with PTFE-tape

Regulier- / Feinreguliertventil
Robinet de réglage / réglage fin
Regulating / fine regulating valve

SO NV 41A21/E/EB/EL
SO NV 41C21/E/EB/EL

12

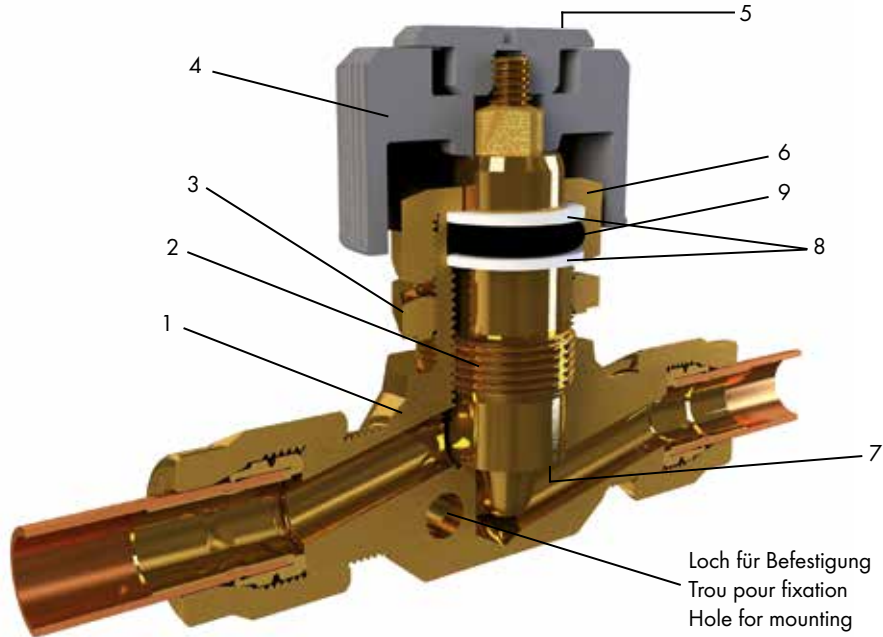

Nr. No. No.	Bezeichnung Désignation Description	Material Matériau Material	Nr. No. No.	Bezeichnung Désignation Description	Material Matériau Material	Nr. No. No.	Bezeichnung Désignation Description	Material Matériau Material
1	Ventilkörper Corps cône de soupape Valve body	Messing Laiton Brass	4	Handrad (grau) Manche (gris) Handwheel (grey)	Polyamid Polyamide Polyamide	7*	Dichtung Joint Seal	NBR/PTFE
2	Ventilspindel Tige de soupape Valve spindle	Messing Laiton Brass	5*	Ventilschild (grau) Plaque indicatrice (gris) Valve label (grey)	Polyamid Polyamide Polyamide	8	Dichtungs-Set Set des joints Set of seals	PVDF
3	Kontermutter Contre-écrou Counter nut	Messing Laiton Brass	6*	Ventilkappe Bouchon de soupape Valve cap	Messing Laiton Brass	9	Dichtung Joint Seal	NBR

Spezifikationen

Betriebsdruck (PN): 50 bar
 Temperatur: -20°C bis +80°C
 Sicherheitsfaktor: 1.5-fach

Merkmale

- Funktion: Regulier- und Absperrventil
- Einsatz: Luft, Wasser, Öle und Flüssiggase (Beständigkeit Dichtung beachten)
- Material: Messing CW617N (CuZn40Pb2)
- Besonderes: kompakte Abmessungen, hohe Zuverlässigkeit

*** Optionen**

- Nr. 5 - Ventilschild: wahlweise auch in den Farben blau, rot und grün, siehe VSD SO NV
- Nr. 6 - Drehmoment für Ventilkappe bei Schalttafelmontage = 3.4 Nm
- Nr. 7 - Dichtung: EPDM, FKM
- Varianten: mit Übergangsmuffe SO 40030 oder Übergangsnippel SO 40040

Spécifications

Pression de service (PN): 50 bar
 Température: -20°C à +80°C
 Facteur de sécurité: 1.5 fois

Caractéristiques

- Fonction: soupape de régulation et de retenue
- Application: air, eau, huiles et gaz liquéfiés (tenir compte de la résistance de l'étanchéité)
- Matériau: laiton CW617N (CuZn40Pb2)
- Particularités : dimensions compactes, grande fiabilité

*** Options**

- No. 5 - Plaques indicatrices: au choix disponible en couleurs bleu, rouge et vert, voir VSD SO NV
- No. 6 - Couple pour bouchon de soupape dans tableau de commande = 3.4 Nm
- No. 7 - Joint: EPDM, FKM
- Autres versions: avec adaptateur femelle SO 40030 ou mâle SO 40040

Specifications

Working pressure (PN): 50 bar
 Temperature: -20°C to +80°C
 Safety factor: 1.5 times

Characteristics

- Function: regulating and stop valve
- Uses: air, water, oils and liquid gases (check resistance of seal)
- Material: brass CW617N (CuZn40Pb2)
- Special: compact dimensions, high reliability

*** Options**

- No. 5 - Valve labels: also available in colors blue, red and green, see VSD SO NV
- No. 6 - Torque for valve cap in panel mounting = 3.4 Nm
- No. 7 - Seal: EPDM, FKM
- Other versions: with female SO 40030 or male adaptor SO 40040

Durchflussdiagramm

Courbe de débit

Flow rate

Reguliventile / Robinets de réglage / Regulating valves

Feinreguliventile / Robinets de réglage fin / Fine regulating valves

SO NV 41A21

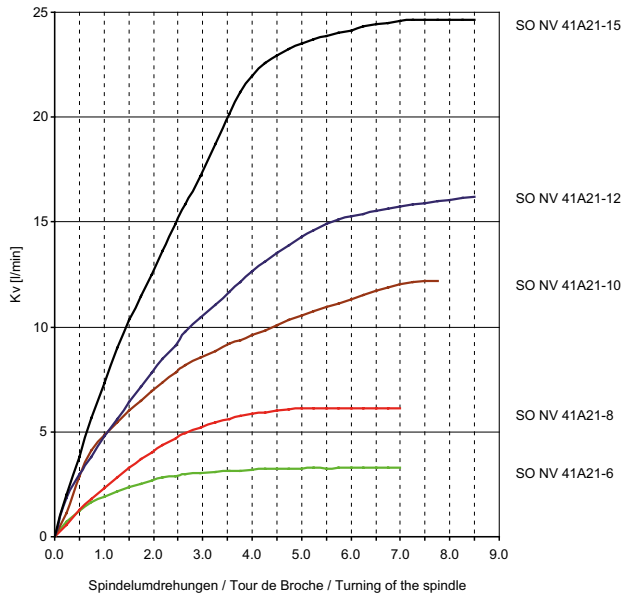

SO NV 41C21

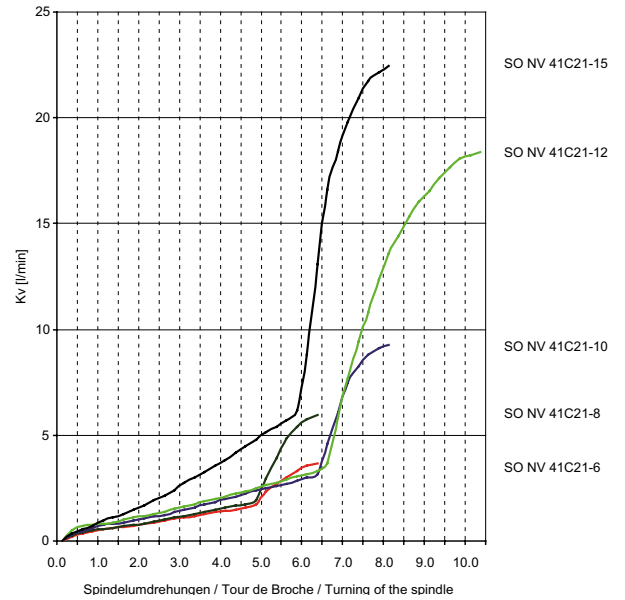

SO NV 41A21E / A21EB / A21EL

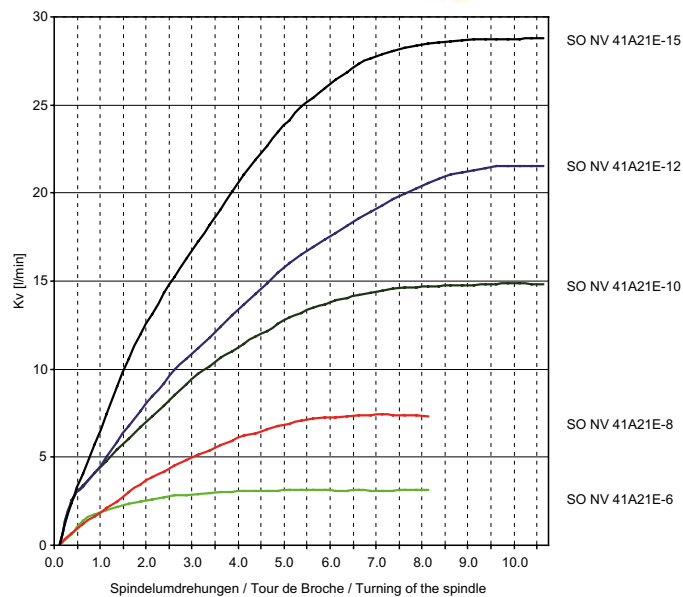

SO NV 41C21E / C21EB / 21EL

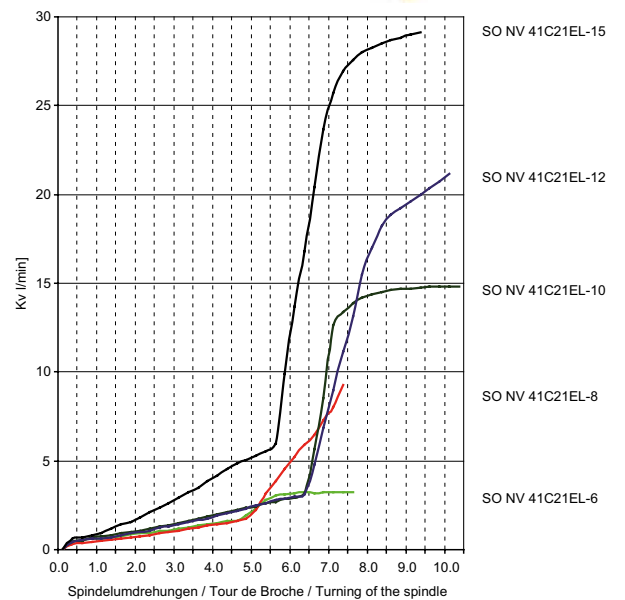

Sonderausführungen

siehe Kapitelübersicht

Exécutions en option

voir aperçu du chapitre

Optional services

see chapter overview

Zubehör

- Anschraubfuss für Wandmontage der Typen SO NV 41A21 und SO NV 41C21 siehe SO 09900

Accessoires

- Support de fixation pour les types SO NV 41A21 et SO NV 41C21 voir SO 09900

Accessoires

- Flange mount for wall fastening for types SO NV 41A21 and SO NV 41C21 see SO 09900

Regulierventil

Robinet de réglage

Regulating valve

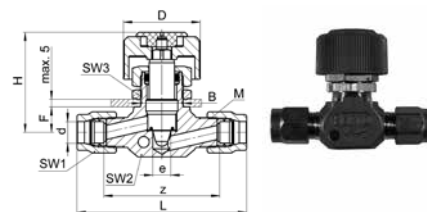

SO NV 41A21

Type-d	Mat.-Nr.	bar	M	SW1	SW2	SW3	L	D	H	B	F	z	e	kv	kg/100	
Für metrische Rohre			Pour tubes métriques					For metric tubes								
* SO NV 41A21-4	028.0000.040	50	10x1	12	14	19	61.0	26.0	47.0	16.5	10.0	46.0	3.4	3.3	10.600	
* SO NV 41A21-5	028.0000.050	50	10x1	12	14	19	61.0	26.0	47.0	16.5	10.0	46.0	4.0	3.3	10.500	
SO NV 41A21-6	028.0000.060	50	10x1	12	14	19	61.0	26.0	47.0	16.5	10.0	46.5	4.0	3.3	10.500	
SO NV 41A21-8	028.0000.080	50	12x1	14	14	19	62.5	26.0	47.0	16.5	10.0	46.5	5.0	6.2	11.300	
SO NV 41A21-10	028.0000.100	50	14x1	17	18	24	75.5	36.0	54.5	20.5	12.0	54.5	6.5	12.1	21.800	
SO NV 41A21-12	028.0000.120	50	16x1	19	18	24	86.5	36.0	56.5	20.5	14.0	62.5	8.0	16.6	25.700	
* SO NV 41A21-13	028.0000.130	50	20x1.5	24	22	27	92.0	36.0	66.0	24.5	15.0	67.0	10.0	24.6	42.000	
SO NV 41A21-14	028.0000.140	50	20x1.5	24	22	27	92.0	36.0	66.0	24.5	15.0	67.0	10.0	24.6	41.800	
SO NV 41A21-15	028.0000.150	50	20x1.5	24	22	27	92.0	36.0	66.0	24.5	15.0	67.0	10.0	24.6	41.200	
Für Zollrohre			Pour tubes pouces					For inch tubes								
SO NV 41A21-6,35	028.0000.063	50	10x1	12	14	19	61.0	26.0	41.5	16.5	10.0	46.0	4.0	3.3	10.400	
SO NV 41A21-9,52	028.0000.095	50	14x1	17	18	24	75.5	36.0	54.5	20.5	12.0	54.5	6.5	12.1	21.700	
* SO NV 41A21-12,7	028.0000.127	50	20x1.5	24	22	27	92.0	36.0	66.0	24.5	15.0	67.0	10.0	24.6	42.000	

Umrechnung für "d" bei Zollrohren:

6,35 = 1/4
 9,52 = 3/8
 12,7 = 1/2

Conversion de "d" pour tubes en pouces:

6,35 = 1/4
 9,52 = 3/8
 12,7 = 1/2

Conversion for "d" for inch tubes:

6,35 = 1/4
 9,52 = 3/8
 12,7 = 1/2

d=Rohrassens-ø

e=kleinste Bohrung

kv=Kenngröße für das Durchflussverhalten (l/min)

L=Mass in montiertem Zustand

*=mit reduziertem Klemmring

d=ø extérieur du tube

e=ø-min. de passage

kv=facteur d'écoulement (l/min)

L=après montage

*=avec bague de serrage de réduction

d=tube outside diameter

e=minimum bore

kv=flow factor (l/min)

L=installed length

*=with reduced compression ferrule

Regulierventil

mit Übergangsmuffe SO 40030

Robinet de réglage

avec adaptateur femelle SO 40030

Regulating valve

with female adaptor SO 40030

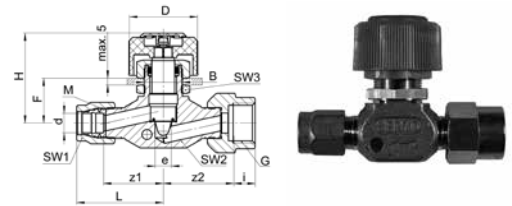
SO NV 41A30

Type -d-G	Mat.-Nr.	bar	M	SW1	SW2	SW3	L	H	F	i	z1	z2	e	kv	kg/100
Für metrische Rohre															
G=Rohrgewinde (zylindrisch)															
SO NV 41A30-4-1/8	028.0200.060	50	10x1	12	14	19	30.5	47.0	19.0	8.0	23.0	28.0	3.4	3.3	11.330
SO NV 41A30-5-1/8	028.0200.082	50	10x1	12	14	19	30.5	47.0	19.0	8.0	23.0	28.0	4.0	3.3	11.330
SO NV 41A30-6-1/8	028.0200.100	50	10x1	12	14	19	30.5	47.0	19.0	8.0	23.0	28.0	4.0	3.3	11.330
SO NV 41A30-6-1/4	028.0200.110	50	10x1	12	14	19	30.5	47.0	19.0	9.0	23.5	28.0	4.0	3.3	12.190
SO NV 41A30-6-3/8	028.0200.120	50	10x1	12	14	19	30.5	47.0	19.0	9.5	23.5	28.5	4.0	3.3	14.460
SO NV 41A30-8-1/8	028.0200.160	50	12x1	14	14	19	31.0	47.0	19.0	8.0	23.5	28.0	5.0	6.2	12.970
SO NV 41A30-8-1/4	028.0200.170	50	12x1	14	14	19	31.0	47.0	19.0	9.0	23.5	29.0	5.0	6.2	12.760
SO NV 41A30-8-3/8	028.0200.180	50	12x1	14	14	19	31.0	47.0	19.0	9.5	23.5	28.5	5.0	6.2	14.960
SO NV 41A30-10-1/4	028.0200.270	50	14x1	17	18	24	38.0	54.5	21.5	9.0	27.5	32.0	6.5	12.1	22.000
SO NV 41A30-10-3/8	028.0200.280	50	14x1	17	18	24	38.0	54.5	21.5	9.0	27.5	32.5	6.5	12.1	24.670
SO NV 41A30-10-1/2	028.0200.285	50	16x1	19	18	24	43.5	56.5	23.5	11.5	32.0	36.5	8.0	16.6	26.186
SO NV 41A30-12-1/4	028.0200.380	50	16x1	19	18	24	43.5	56.5	23.5	9.0	32.0	36.0	8.0	16.6	26.140
SO NV 41A30-12-3/8	028.0200.390	50	16x1	19	18	24	43.5	56.5	23.5	9.5	32.0	36.5	8.0	16.6	27.450
SO NV 41A30-12-1/2	028.0200.400	50	16x1	19	18	24	43.5	56.5	23.5	11.5	32.0	36.5	8.0	16.6	30.630
SO NV 41A30-14-1/2	028.0200.504	50	20x1.5	24	22	27	46.0	66.0	27.5	11.5	33.5	39.5	10.0	24.6	43.770
SO NV 41A30-15-1/2	028.0200.534	50	20x1.5	27	22	27	46.0	66.0	27.5	11.5	33.5	39.5	10.0	24.6	44.090
Für Zollrohre															
SO NV 41A30-6,35-1/8	028.0200.135	50	10x1	12	14	19	30.5	41.5	19.0	8.0	23.0	28.0	4.0	3.3	11.340
SO NV 41A30-9,52-1/4	028.0200.230	50	14x1	17	18	24	38.0	54.5	21.5	9.0	28.0	32.0	6.5	12.1	21.940
SO NV 41A30-9,52-3/8	028.0200.235	50	14x1	17	18	24	38.0	54.5	21.5	9.5	28.0	32.5	6.5	12.1	24.610
SO NV 41A30-12,7-3/8	028.0200.432	50	20x1.5	24	22	27	46.0	66.0	27.5	9.5	23.5	39.5	10.0	24.6	42.060
SO NV 41A30-12,7-1/2	028.0200.434	50	20x1.5	24	22	27	46.0	66.0	27.5	11.5	23.5	39.5	10.0	24.6	44.090
SO NV 41A30-12,7-3/4	028.0200.436	50	20x1.5	24	22	27	46.0	66.0	27.5	14.0	23.5	40.0	10.0	24.6	47.940

Umrechnung für "d" bei Zollrohren:

6,35 = 1/4

9,52 = 3/8

12,7 = 1/2

Conversion de "d" pour tubes en pouces:

6,35 = 1/4

9,52 = 3/8

12,7 = 1/2

Conversion for "d" for inch tubes:

6,35 = 1/4

9,52 = 3/8

12,7 = 1/2

 D = ø 26 mm ≤ Anschlussgröße 8
 ø 36 mm ≥ Anschlussgröße 9,52

 D = ø 26 mm ≤ Dimension 8
 ø 36 mm ≥ Dimension 9,52

 D = ø 26 mm ≤ Dimension 8
 ø 36 mm ≥ Dimension 9,52

 B = ø 16,5 mm ≤ Anschlussgröße 8
 ø 20,5 mm ≥ Anschlussgröße 9,52
 ø 24,5 mm ≥ Anschlussgröße 14

 B = ø 16,5 mm ≤ Dimension 8
 ø 20,5 mm ≥ Dimension 9,52
 ø 24,5 mm ≥ Dimension 14

 B = ø 16,5 mm ≤ Dimension 8
 ø 20,5 mm ≥ Dimension 9,52
 ø 24,5 mm ≥ Dimension 14

d=Rohrassen-ø

e=kleinste Bohrung

kv=Kenngröße für das Durchflussverhalten (l/min)

L=Mass in montiertem Zustand

*=mit reduziertem Klemmring

d=ø extérieur du tube

e=ø-min. de passage

kv=facteur d'écoulement (l/min)

L=après montage

*=avec bague de serrage de réduction

d=tube outside diameter

e=minimum bore

kv=flow factor (l/min)

L=installed length

*=with reduced compression ferrule

Regulierventil

mit Übergangsnippel SO 40040

Robinet de réglage

avec adaptateur mâle SO 40040

Regulating valve

with male adaptor SO 40040

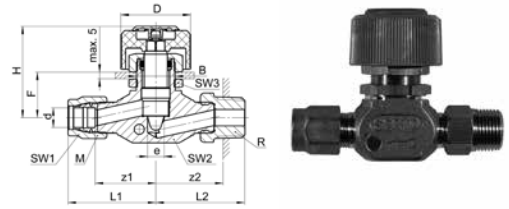
SO NV 41A40

Type -d-R		bar	M	SW1	SW2	SW3	L1	L2	H	F	z1	z2	e	kv	kg/100	
Für metrische Rohre		Pour tubes métriques						For metric tubes								
R=Rohrgewinde (kegelig)		R=Filetage-gaz BSP (conique)						R=BSP thread (tapered)								
SO NV 41A40-4-1/8	028.0300.060	50	10x1	12	14	19	30.5	33.0	47.0	19.0	23.0	26.5	3.4	3.7	10.460	
SO NV 41A40-4-1/4	028.0300.065	50	10x1	12	14	19	30.5	37.0	47.0	19.0	23.0	27.5	3.4	3.7	11.510	
SO NV 41A40-4-3/8	028.0300.068	50	10x1	12	14	19	30.5	36.0	47.0	19.0	23.0	26.0	3.4	3.7	12.690	
SO NV 41A40-5-1/8	028.0300.082	50	10x1	12	14	19	30.5	33.0	47.0	19.0	23.0	26.5	4.0	3.7	10.460	
SO NV 41A40-5-1/4	028.0300.084	50	10x1	12	14	19	30.5	37.0	47.0	19.0	23.0	27.5	4.0	3.7	11.510	
SO NV 41A40-6-1/8	028.0300.100	50	10x1	12	14	19	30.5	33.0	47.0	19.0	23.5	26.5	4.0	3.7	10.460	
SO NV 41A40-6-1/4	028.0300.110	50	10x1	12	14	19	30.5	37.0	47.0	19.0	23.0	27.5	4.0	3.7	11.510	
SO NV 41A40-6-3/8	028.0300.120	50	10x1	12	14	19	30.5	36.0	47.0	19.0	23.5	26.0	4.0	3.7	12.690	
SO NV 41A40-8-1/8	028.0300.160	50	12x1	14	14	19	31.0	33.0	47.0	19.0	23.0	26.5	5.0	6.0	11.170	
SO NV 41A40-8-1/4	028.0300.170	50	12x1	14	14	19	31.0	37.0	47.0	19.0	23.5	27.5	5.0	6.0	11.700	
SO NV 41A40-8-3/8	028.0300.180	50	12x1	14	14	19	31.0	37.0	47.0	19.0	23.5	27.0	5.0	6.0	13.150	
SO NV 41A40-10-1/4	028.0300.270	50	14x1	17	18	24	38.0	41.0	54.5	21.5	27.5	31.5	6.5	9.2	21.620	
SO NV 41A40-10-3/8	028.0300.280	50	14x1	17	18	24	38.0	41.0	54.5	21.5	27.5	31.0	6.5	9.2	22.350	
SO NV 41A40-10-1/2	028.0300.285	50	14x1	17	18	24	38.0	44.0	54.5	21.5	27.5	31.0	6.5	9.2	24.940	
SO NV 41A40-12-1/4	028.0300.380	50	16x1	19	18	24	43.5	46.0	56.5	23.5	32.0	36.5	8.0	18.4	25.470	
SO NV 41A40-12-3/8	028.0300.390	50	16x1	19	18	24	43.5	46.0	56.5	23.5	32.0	36.0	8.0	18.4	26.230	
SO NV 41A40-12-1/2	028.0300.400	50	16x1	19	18	24	43.5	49.0	56.5	23.5	32.0	36.0	8.0	18.4	28.200	
SO NV 41A40-14-1/2	028.0300.504	50	20x1.5	24	22	27	46.0	50.0	66.0	27.5	33.5	37.0	10.0	22.3	41.070	
SO NV 41A40-15-1/2	028.0300.534	50	20x1.5	24	22	27	46.0	50.0	66.0	27.5	33.5	37.0	10.0	22.3	41.390	

Für Zollrohre		Pour tubes pouces						For inch tubes								
SO NV 41A40-6,35-1/8	028.0300.135	50	10x1	12	14	19	30.5	33.0	41.5	19.0	23.0	26.5	4.0	3.7	10.470	
SO NV 41A40-6,35-1/4	028.0300.140	50	10x1	12	14	19	30.5	37.0	41.5	19.0	23.0	27.5	4.0	3.7	11.520	
SO NV 41A40-6,35-3/8	028.0300.145	50	10x1	12	14	19	30.5	36.0	41.5	19.0	23.0	26.0	4.0	3.7	12.700	
SO NV 41A40-9,52-1/4	028.0300.230	50	14x1	17	18	24	38.0	48.0	54.5	21.5	27.5	31.5	6.5	9.2	21.560	
SO NV 41A40-9,52-3/8	028.0300.235	50	14x1	17	18	24	38.0	41.0	54.5	21.5	27.5	31.0	6.5	9.2	22.290	
SO NV 41A40-9,52-1/2	028.0300.240	50	14x1	17	18	24	38.0	42.0	54.5	21.5	27.5	29.0	6.5	9.2	24.880	
SO NV 41A40-12,7-3/8	028.0300.432	50	20x1.5	24	22	27	46.0	48.0	66.0	27.5	33.5	38.0	10.0	22.3	40.720	
SO NV 41A40-12,7-1/2	028.0300.434	50	20x1.5	24	22	27	46.0	50.0	66.0	27.5	33.5	37.0	10.0	22.3	41.390	

Umrechnung für "d" bei Zollrohren:

$6,35 = 1/4$

$9,52 = 3/8$

$12,7 = 1/2$

Conversion de "d" pour tubes en pouces:

$6,35 = 1/4$

$9,52 = 3/8$

$12,7 = 1/2$

Conversion for "d" for inch tubes:

$6,35 = 1/4$

$9,52 = 3/8$

$12,7 = 1/2$

 $D = \varnothing 26 \text{ mm} \leq \text{Anschlussgröße } 8$
 $\varnothing 36 \text{ mm} \geq \text{Anschlussgröße } 9,52$
 $D = \varnothing 26 \text{ mm} \leq \text{Dimension } 8$
 $\varnothing 36 \text{ mm} \geq \text{Dimension } 9,52$
 $D = \varnothing 26 \text{ mm} \leq \text{Dimension } 8$
 $\varnothing 36 \text{ mm} \geq \text{Dimension } 9,52$
 $B = \varnothing 16,5 \text{ mm} \leq \text{Anschlussgröße } 8$
 $\varnothing 20,5 \text{ mm} \geq \text{Anschlussgröße } 9,52$
 $\varnothing 24,5 \text{ mm} \geq \text{Anschlussgröße } 14$
 $B = \varnothing 16,5 \text{ mm} \leq \text{Dimension } 8$
 $\varnothing 20,5 \text{ mm} \geq \text{Dimension } 9,52$
 $\varnothing 24,5 \text{ mm} \geq \text{Dimension } 14$
 $B = \varnothing 16,5 \text{ mm} \leq \text{Dimension } 8$
 $\varnothing 20,5 \text{ mm} \geq \text{Dimension } 9,52$
 $\varnothing 24,5 \text{ mm} \geq \text{Dimension } 14$

d=Rohrassen-ø

e=kleinste Bohrung

kv=Kenngröße für das Durchflussverhalten (l/min)

L=Mass in montiertem Zustand

*=mit reduziertem Klemmring

d=ø extérieur du tube

e=ø-min. de passage

kv=facteur d'écoulement (l/min)

L=après montage

*=avec bague de serrage de réduction

d=tube outside diameter

e=minimum bore

kv=flow factor (l/min)

L=installed length

*=with reduced compression ferrule

Feinreguliertventil
Robinet de réglage fin
Fine regulating valve

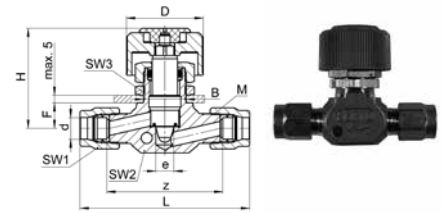
SO NV 41C21

Type -d	Mat.-Nr.	bar	M	SW1	SW2	SW3	L	D	H	B	F	z	e	kv	kg/100	
Für metrische Rohre			Pour tubes métriques					For metric tubes								
* SO NV 41C21-4	028.0500.040	50	10x1	12	14	19	61.0	26.0	47.0	16.5	10.0	46.0	3.4	3.7	10.600	
* SO NV 41C21-5	028.0500.050	50	10x1	12	14	19	61.0	26.0	47.0	16.5	10.0	46.0	4.0	3.7	10.500	
SO NV 41C21-6	028.0500.060	50	10x1	12	14	19	61.0	26.0	47.0	16.5	10.0	46.5	4.0	3.7	10.500	
SO NV 41C21-8	028.0500.080	50	12x1	14	14	19	62.5	26.0	47.0	16.5	10.0	46.5	5.0	6.0	11.300	
SO NV 41C21-10	028.0500.100	50	14x1	17	18	24	75.5	36.0	54.5	20.5	12.0	54.5	6.5	9.2	21.800	
SO NV 41C21-12	028.0500.120	50	16x1	19	18	24	86.5	36.0	56.5	20.5	14.0	62.5	8.0	18.4	25.700	
* SO NV 41C21-13	028.0500.130	50	20x1.5	24	22	27	92.0	36.0	66.0	24.5	15.0	67.0	10.0	22.3	42.000	
SO NV 41C21-14	028.0500.140	50	20x1.5	24	22	27	92.0	36.0	66.0	24.5	15.0	67.0	10.0	22.3	41.800	
SO NV 41C21-15	028.0500.150	50	20x1.5	24	22	27	92.0	36.0	66.0	24.5	15.0	67.0	10.0	22.3	41.200	
Für Zollrohre			Pour tubes pouces					For inch tubes								
SO NV 41C21-6,35	028.0500.063	50	10x1	12	14	19	61.0	26.0	47.0	16.5	10.0	46.0	4.0	3.7	10.400	
SO NV 41C21-9,52	028.0500.095	50	14x1	17	18	24	75.5	36.0	54.5	20.5	12.0	54.0	6.5	9.2	21.700	
* SO NV 41C21-12,7	028.0500.127	50	20x1.5	24	22	27	92.0	36.0	66.0	24.5	15.0	67.0	10.0	22.3	42.000	

Umrechnung für "d" bei Zollrohren:

6,35 = 1/4
 9,52 = 3/8
 12,7 = 1/2

Conversion de "d" pour tubes en pouces:

6,35 = 1/4
 9,52 = 3/8
 12,7 = 1/2

Conversion for "d" for inch tubes:

6,35 = 1/4
 9,52 = 3/8
 12,7 = 1/2

d=Rohrassens-ø
 e=kleinste Bohrung
 kv=Kenngröße für das Durchflussverhalten (l/min)
 L=Mass in montiertem Zustand
 *=mit reduziertem Klemmring

d=ø extérieur du tube
 e=ø-min. de passage
 kv=facteur d'écoulement (l/min)
 L=après montage
 *=avec bague de serrage de réduction

d=tube outside diameter
 e=minimum bore
 kv=flow factor (l/min)
 L=installed length
 *=with reduced compression ferrule

Regulier-Eckventil

Robinet-équerre de réglage

Elbow regulating valve

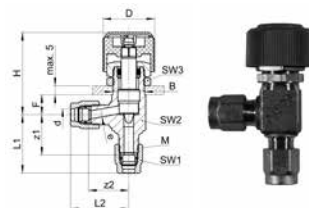

SO NV 41A21E

Type-d	Mat.-Nr.	bar	M	SW1	SW2	SW3	L1	L2	H	F	z1	z2	e	kv	kg/100	
Für metrische Rohre		Pour tubes métriques						For metric tubes								
* SO NV 41A21E-4	028.1500.040	50	10x1	12	14	19	29.0	29.0	41.0	10.0	20.0	20.0	3.4	5.0	10.500	
* SO NV 41A21E-5	028.1500.050	50	10x1	12	14	19	29.0	29.0	41.0	10.0	20.0	20.0	4.0	5.5	10.400	
SO NV 41A21E-6	028.1500.060	50	10x1	12	14	19	29.0	29.0	41.0	10.0	20.0	20.0	4.0	6.0	10.300	
SO NV 41A21E-8	028.1500.080	50	12x1	14	14	19	31.0	31.0	41.0	10.0	21.0	21.0	4.8	8.0	11.400	
SO NV 41A21E-10	028.1500.100	50	14x1	17	19	24	37.0	37.0	45.0	12.0	24.0	24.0	6.5	16.0	20.500	
SO NV 41A21E-12	028.1500.120	50	16x1	19	19	24	38.0	38.0	45.0	12.0	24.0	24.0	8.3	24.0	22.100	
SO NV 41A21E-14	028.1500.140	50	20x1.5	24	22	24	42.5	42.5	53.0	15.0	27.5	27.5	8.3	50.0	36.600	
SO NV 41A21E-15	028.1500.150	50	20x1.5	24	22	27	42.5	42.5	53.0	15.0	27.5	27.5	10.8	50.0	36.300	
Für Zollrohre		Pour tubes pouces						For inch tubes								
SO NV 41A21E-6,35	028.1500.063	50	10x1	12	14	19	29.0	29.0	41.0	10.0	20.0	20.0	4.0	6.0	10.300	
SO NV 41A21E-9,52	028.1500.095	50	14x1	17	19	24	37.0	37.0	45.0	12.0	24.0	24.0	6.5	15.0	20.600	
* SO NV 41A21E-12,7	028.1500.127	50	20x1.5	24	22	24	42.5	42.5	53.0	15.0	27.5	27.5	10.8	45.0	37.100	

Umrechnung für "d" bei Zollrohren:

6,35 = 1/4
 9,52 = 3/8
 12,7 = 1/2

Conversion de "d" pour tubes en pouces:

6,35 = 1/4
 9,52 = 3/8
 12,7 = 1/2

Conversion for "d" for inch tubes:

6,35 = 1/4
 9,52 = 3/8
 12,7 = 1/2

D = ø 20 mm ≤ Anschlussgröße 8
 ø 32 mm ≥ Anschlussgröße 9,52

D = ø 20 mm ≤ Dimension 8
 ø 32 mm ≥ Dimension 9,52

D = ø 20 mm ≤ Dimension 8
 ø 32 mm ≥ Dimension 9,52

B = ø 16,5 mm ≤ Anschlussgröße 8
 ø 20,5 mm ≥ Anschlussgröße 9,52

B = ø 16,5 mm ≤ Dimension 8
 ø 20,5 mm ≥ Dimension 9,52

B = ø 16,5 mm ≤ Dimension 8
 ø 20,5 mm ≥ Dimension 9,52

d=Rohrassen-ø
 e=kleinste Bohrung
 kv=Kenngröße für das Durchflussverhalten (l/min)
 L=Mass in montiertem Zustand
 *=mit reduziertem Klemmring

d=ø extérieur du tube
 e=ø-min. de passage
 kv=facteur d'écoulement (l/min)
 L=après montage
 *=avec bague de serrage de réduction

d=tube outside diameter
 e=minimum bore
 kv=flow factor (l/min)
 L=installed length
 *=with reduced compression ferrule

Regulier-Eckventil

mit Übergangsmuffe SO 40030

Robinet-équerre de réglage

avec adaptateur femelle SO 40030

Elbow regulating valve

with female adaptor SO 40030

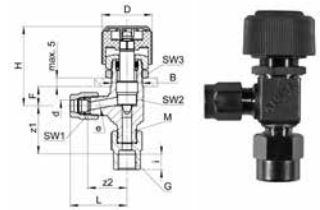
SO NV 41A30E

Type -d-G	Mat.-Nr.	bar	M	SW1	SW2	SW3	L	H	F	i	z1	z2	e	kv	kg/100	
Für metrische Rohre				Pour tubes métriques								For metric tubes				
G=Rohrgewinde (zylindrisch)				G=Filetage-gaz BSP (cylindrique)								G=BSP thread (parallel)				
SO NV 41A30E-4-1/8	028.1700.060	50	10x1	12	14	19	27.5	46.0	10.0	8.0	25.0	20.0	3.4	5.0	11.600	
SO NV 41A30E-5-1/8	028.1700.082	50	10x1	12	14	19	27.5	46.0	10.0	8.0	25.0	20.0	4.0	5.5	11.610	
SO NV 41A30E-6-1/8	028.1700.100	50	10x1	12	14	19	27.5	46.0	10.0	8.0	25.0	20.0	4.0	6.0	11.330	
SO NV 41A30E-6-1/4	028.1700.110	50	10x1	12	14	19	27.5	46.0	10.0	9.0	25.0	20.0	4.0	6.0	12.190	
SO NV 41A30E-6-3/8	028.1700.120	50	10x1	12	14	19	27.5	46.0	10.0	9.5	25.5	20.0	4.0	6.0	14.460	
SO NV 41A30E-8-1/8	028.1700.160	50	12x1	14	14	19	29.0	46.0	10.0	8.0	26.0	21.0	4.8	8.0	13.070	
SO NV 41A30E-8-1/4	028.1700.170	50	12x1	14	14	19	29.0	46.0	10.0	9.0	27.0	21.0	4.8	8.0	12.820	
SO NV 41A30E-8-3/8	028.1700.180	50	12x1	14	14	19	29.0	46.0	10.0	9.5	26.5	21.0	4.8	8.0	15.060	
SO NV 41A30E-10-1/4	028.1700.270	50	14x1	17	19	24	34.0	54.0	12.0	9.0	29.0	24.0	6.5	16.0	20.700	
SO NV 41A30E-10-3/8	028.1700.280	50	14x1	17	19	24	34.0	54.0	12.0	9.5	29.5	24.0	6.5	16.0	23.370	
SO NV 41A30E-10-1/2	028.1700.285	50	16x1	19	19	24	36.0	54.0	12.0	11.5	29.5	24.0	8.3	16.0	22.586	
SO NV 41A30E-12-1/4	028.1700.380	50	16x1	19	19	24	36.0	54.0	12.0	9.0	29.0	24.0	8.3	24.0	22.540	
SO NV 41A30E-12-3/8	028.1700.390	50	16x1	19	19	24	36.0	54.0	12.0	9.5	29.5	24.0	8.3	24.0	23.850	
SO NV 41A30E-12-1/2	028.1700.400	50	16x1	19	19	24	36.0	54.0	12.0	11.5	29.5	24.0	8.3	24.0	27.030	
SO NV 41A30E-14-1/2	028.1700.504	50	20x1.5	24	22	27	40.0	66.0	15.0	11.5	32.5	27.0	10.8	50.0	38.870	
SO NV 41A30E-15-1/2	028.1700.534	50	20x1.5	24	22	27	40.0	66.0	15.0	11.5	32.5	27.0	10.8	50.0	39.190	
Für Zollrohre				Pour tubes pouces								For inch tubes				
SO NV 41A30E-6,35-1/8	028.1700.135	50	10x1	12	14	19	27.5	46.0	10.0	8.0	25.0	20.0	4.0	6.0	11.140	
SO NV 41A30E-6,35-1/4	028.1700.140	50	10x1	12	14	19	27.5	46.0	10.0	9.0	25.0	20.0	4.0	6.0	12.000	
SO NV 41A30E-6,35-3/8	028.1700.145	50	10x1	12	14	19	27.5	46.0	10.0	9.5	25.5	20.0	4.0	6.0	14.270	
SO NV 41A30E-9,52-1/4	028.1700.230	50	14x1	17	19	24	34.0	54.0	12.0	9.0	29.0	24.0	6.5	15.0	20.740	
SO NV 41A30E-9,52-3/8	028.1700.235	50	14x1	17	19	24	34.0	54.0	12.0	9.5	29.5	24.0	6.5	15.0	23.410	

Umrechnung für "d" bei Zollrohren:

$$6,35 = 1/4$$

$$9,52 = 3/8$$

Conversion de "d" pour tubes en pouces:

$$6,35 = 1/4$$

$$9,52 = 3/8$$

Conversion for "d" for inch tubes:

$$6,35 = 1/4$$

$$9,52 = 3/8$$

 $D = \varnothing 26 \text{ mm} \leq \text{Anschlussgrösse } 8$
 $\varnothing 36 \text{ mm} \geq \text{Anschlussgrösse } 9,52$
 $D = \varnothing 26 \text{ mm} \leq \text{Dimension } 8$
 $\varnothing 36 \text{ mm} \geq \text{Dimension } 9,52$
 $D = \varnothing 26 \text{ mm} \leq \text{Dimension } 8$
 $\varnothing 36 \text{ mm} \geq \text{Dimension } 9,52$
 $B = \varnothing 16,5 \text{ mm} \leq \text{Anschlussgrösse } 8$
 $\varnothing 20,5 \text{ mm} \geq \text{Anschlussgrösse } 9,52$
 $\varnothing 24,5 \text{ mm} \geq \text{Anschlussgrösse } 14$
 $B = \varnothing 16,5 \text{ mm} \leq \text{Dimension } 8$
 $\varnothing 20,5 \text{ mm} \geq \text{Dimension } 9,52$
 $\varnothing 24,5 \text{ mm} \geq \text{Dimension } 14$
 $B = \varnothing 16,5 \text{ mm} \leq \text{Dimension } 8$
 $\varnothing 20,5 \text{ mm} \geq \text{Dimension } 9,52$
 $\varnothing 24,5 \text{ mm} \geq \text{Dimension } 14$

d=Rohraussen-ø

e=kleinste Bohrung

kv=Kenngrösse für das Durchflussverhalten (l/min)

L=Mass in montiertem Zustand

*=mit reduziertem Klemmring

d=ø extérieur du tube

e=ø-min. de passage

kv=facteur d'écoulement (l/min)

L=après montage

*=avec bague de serrage de réduction

d=tube outside diameter

e=minimum bore

kv=flow factor (l/min)

L=installed length

*=with reduced compression ferrule

Regulier-Eckventil

mit Übergangsnippel SO 40040

Robinet-équerre de réglage

avec adaptateur mâle SO 40040

Elbow regulating valve

with male adaptor SO 40040

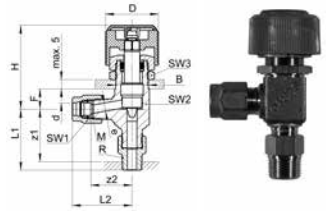
SO NV 41A40E

Type -d-R	Mat.-Nr.	bar	M	SW1	SW2	SW3	L1	L2	H	F	z1	z2	e	kv	kg/100	
Für metrische Rohre			Pour tubes métriques							For metric tubes						
R=Rohrgewinde (kegelig)			R=Filetage-gaz BSP (conique)							R=BSP thread (tapered)						
SO NV 41A40E-4-1/4	028.1800.065	50	10x1	10	14	19	34.0	26.0	42.0	10.0	24.5	20.0	3.4	5.0	11.780	
SO NV 41A40E-5-1/4	028.1800.084	50	10x1	10	14	19	34.0	26.5	42.0	10.0	24.5	20.0	4.0	5.5	11.750	
SO NV 41A40E-6-1/8	028.1800.100	50	10x1	10	14	19	30.0	28.0	42.0	10.0	23.5	20.0	4.0	6.0	10.260	
SO NV 41A40E-6-1/4	028.1800.110	50	10x1	10	14	19	34.0	28.0	42.0	10.0	24.5	20.0	4.0	6.0	11.310	
SO NV 41A40E-6-3/8	028.1800.120	50	10x1	10	14	19	33.0	28.0	42.0	10.0	23.0	20.0	4.0	6.0	12.490	
SO NV 41A40E-8-1/8	028.1800.160	50	12x1	14	14	19	34.0	29.0	42.0	12.0	27.5	21.0	4.8	8.0	11.270	
SO NV 41A40E-8-1/4	028.1800.170	50	12x1	14	14	19	38.0	29.0	42.0	12.0	28.5	21.0	4.8	8.0	11.800	
SO NV 41A40E-8-3/8	028.1800.180	50	12x1	14	14	19	38.0	29.0	42.0	12.0	28.0	21.0	4.8	8.0	13.250	
SO NV 41A40E-10-1/4	028.1800.270	50	14x1	17	19	24	38.0	34.0	49.0	12.0	28.5	24.0	6.5	16.0	20.320	
SO NV 41A40E-10-3/8	028.1800.280	50	14x1	17	19	24	38.0	34.0	49.0	12.0	28.0	24.0	6.5	16.0	21.050	
SO NV 41A40E-10-1/2	028.1800.285	50	14x1	17	19	24	38.0	34.0	49.0	12.0	28.0	24.0	6.5	16.0	23.640	
SO NV 41A40E-12-1/4	028.1800.380	50	16x1	19	19	24	39.0	35.0	49.0	12.0	29.5	24.0	8.3	24.0	21.870	
SO NV 41A40E-12-3/8	028.1800.390	50	16x1	19	19	24	39.0	35.0	49.0	12.0	29.0	24.0	8.3	24.0	22.630	
SO NV 41A40E-12-1/2	028.1800.400	50	16x1	19	19	24	40.0	35.0	49.0	12.0	27.0	24.0	8.3	24.0	24.600	
SO NV 41A40E-14-1/2	028.1800.504	50	20x1.5	24	22	27	44.0	39.5	57.5	15.0	31.0	27.0	10.8	50.0	36.170	
SO NV 41A40E-15-1/2	028.1800.534	50	20x1.5	24	22	27	44.0	39.5	57.5	15.0	31.0	27.0	10.8	50.0	36.490	
Für Zollrohre			Pour tubes pouces							For inch tubes						
SO NV 41A40E-9,52-1/4	028.1800.230	50	14x1	17	19	24	38.0	34.0	49.0	12.0	28.5	24.0	6.5	15.0	20.360	
SO NV 41A40E-9,52-3/8	028.1800.235	50	14x1	17	19	24	38.0	34.0	49.0	12.0	28.0	24.0	6.5	15.0	21.090	
SO NV 41A40E-9,52-1/2	028.1800.240	50	14x1	17	19	24	39.0	34.0	49.0	12.0	26.0	24.0	6.5	15.0	23.680	

 Umrechnung für "d" bei Zollrohren:
 9,52 = 3/8

 Conversion de "d" pour tubes en pouces:
 9,52 = 3/8

 Conversion for "d" for inch tubes:
 9,52 = 3/8

 D = ø 26 mm ≤ Anschlussgröße 8
 ø 36 mm ≥ Anschlussgröße 9,52

 D = ø 26 mm ≤ Dimension 8
 ø 36 mm ≥ Dimension 9,52

 D = ø 26 mm ≤ Dimension 8
 ø 36 mm ≥ Dimension 9,52

 B = ø 16,5 mm ≤ Anschlussgröße 8
 ø 20,5 mm ≥ Anschlussgröße 9,52
 ø 24,5 mm ≥ Anschlussgröße 14

 B = ø 16,5 mm ≤ Dimension 8
 ø 20,5 mm ≥ Dimension 9,52
 ø 24,5 mm ≥ Dimension 14

 B = ø 16,5 mm ≤ Dimension 8
 ø 20,5 mm ≥ Dimension 9,52
 ø 24,5 mm ≥ Dimension 14

 d=Rohrassen-ø
 e=kleinste Bohrung
 kv=Kenngröße für das Durchflussverhalten (l/min)
 L=Mass in montiertem Zustand
 *=mit reduziertem Klemmring

 d=ø extérieur du tube
 e=ø-min. de passage
 kv=facteur d'écoulement (l/min)
 L=après montage
 *=avec bague de serrage de réduction

 d=tube outside diameter
 e=minimum bore
 kv=flow factor (l/min)
 L=installed length
 *=with reduced compression ferrule

Regulier-Eckventil

mit Einschraubgewinde

Robinet-équerre de réglage

avec filetage mâle

Elbow regulating valve

with male adaptor thread

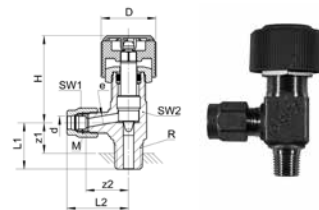

SO NV 41A21EB

Type -d -R	Mat.-Nr.	bar	M	SW1	SW2	L1	L2	D	H	z1	z2	e	kv	kg/100
Für metrische Rohre														
R=Rohrgewinde (kegelig)														

Für Zollrohre

Pour tubes pouces

For inch tubes

SO NV 41A21EB-6,35-1/8	028.1600.135	50	10x1	12	14	19.0	27.5	26.0	46.0	11.0	20.0	4.0	6.0	9.400
SO NV 41A21EB-9,52-3/8	028.1600.230	50	14x1	17	19	25.5	34.0	36.0	54.0	16.0	24.0	6.5	15.0	18.600
* SO NV 41A21EB-12,7-1/2	028.1600.434	50	20x1.5	24	22	31.0	40.0	36.0	66.0	18.0	27.5	10.8	45.0	33.300

Umrechnung für "d" bei Zollrohren:

6,35 = 1/4
9,52 = 3/8
12,7 = 1/2

Conversion de "d" pour tubes en pouces:

6,35 = 1/4
9,52 = 3/8
12,7 = 1/2

Conversion for "d" for inch tubes:

6,35 = 1/4
9,52 = 3/8
12,7 = 1/2

d=Rohrassen-ø

e=kleinste Bohrung

kv=Kenngröße für das Durchflussverhalten (l/min)

L=Mass in montiertem Zustand

*=mit reduziertem Klemmring

d=ø extérieur du tube

e=ø-min. de passage

kv=facteur d'écoulement (l/min)

L=après montage

*=avec bague de serrage de réduction

d=tube outside diameter

e=minimum bore

kv=flow factor (l/min)

L=installed length

*=with reduced compression ferrule

Regulier-Eckventil

mit Einstellzapfen

Robinet-équerre de réglage

orientable

Elbow regulating valve

adjustable

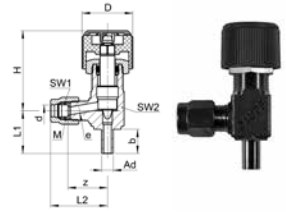

SO NV 41A21EL

Type -d -Ad	Mat.-Nr.	bar	M	SW1	SW2	L1	L2	D	H	b	z	e	kv	kg/100	
Für metrische Rohre			Pour tubes métriques					For metric tubes							
* SO NV 41A21EL-4-A6	028.1560.045	50	10x1	12	14	22.0	27.5	26.0	46.0	12.5	20.0	3.4	5.0	9.400	
* SO NV 41A21EL-5-A6	028.1560.053	50	10x1	12	14	22.0	27.5	26.0	46.0	12.5	20.0	4.0	5.5	9.400	
SO NV 41A21EL-6-A6	028.1560.060	50	10x1	12	14	22.0	27.5	26.0	46.0	12.5	20.0	4.0	6.0	9.400	
* SO NV 41A21EL-6-A8	028.1560.063	50	12x1	14	14	22.0	29.0	26.0	46.0	12.5	21.0	4.5	7.5	10.600	
SO NV 41A21EL-8-A8	028.1560.080	50	12x1	14	14	22.0	29.0	26.0	46.0	12.5	21.0	5.0	8.0	10.600	

Für Zollrohre

Pour tubes pouces

For inch tubes

SO NV 41A21EL-6,35-A6	028.1560.067	50	10x1	12	14	22.0	27.5	26.0	46.0	12.5	20.0	4.0	6.0	9.400
-----------------------	--------------	----	------	----	----	------	------	------	------	------	------	-----	-----	-------

Umrechnung für "d" bei Zollrohren:
6,35 = 1/4

Conversion de "d" pour tubes en pouces:
6,35 = 1/4

Conversion for "d" for inch tubes:
6,35 = 1/4

d=Rohrassens-ø
e=kleinste Bohrung
kv=Kenngröße für das Durchflussverhalten (l/min)
L=Mass in montiertem Zustand
*=mit reduziertem Klemmring

d=ø extérieur du tube
e=ø-min. de passage
kv=facteur d'écoulement (l/min)
L=après montage
*=avec bague de serrage de réduction

d=tube outside diameter
e=minimum bore
kv=flow factor (l/min)
L=installed length
*=with reduced compression ferrule

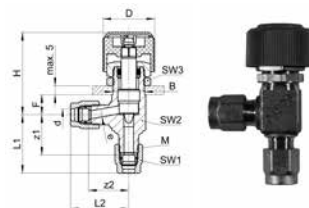
Feinregulier-Eckventil
Robinet-équerre de réglage fin
Elbow fine regulating valve

SO NV 41C21E

Type-d	Mat.-Nr.	bar	M	SW1	SW2	SW3	L1	L2	H	F	z1	z2	e	kv	kg/100	
Für metrische Rohre		Pour tubes métriques						For metric tubes								
* SO NV 41C21E-4	028.2000.040	50	10x1	12	14	19	29.0	29.0	41.0	10.0	20.0	20.0	3.4	4.5	10.500	
* SO NV 41C21E-5	028.2000.050	50	10x1	12	14	19	29.0	29.0	41.0	10.0	20.0	20.0	4.0	5.0	10.400	
SO NV 41C21E-6	028.2000.060	50	10x1	12	14	19	29.0	29.0	41.0	10.0	20.0	20.0	4.0	5.5	10.300	
SO NV 41C21E-8	028.2000.080	50	12x1	14	14	19	31.0	31.0	41.0	10.0	21.0	21.0	4.8	6.5	11.400	
SO NV 41C21E-10	028.2000.100	50	14x1	17	19	24	37.0	37.0	45.0	12.0	24.0	24.0	6.5	15.0	20.500	
SO NV 41C21E-12	028.2000.120	50	16x1	19	19	24	38.0	38.0	45.0	12.0	24.0	24.0	8.3	22.0	22.100	
SO NV 41C21E-14	028.2000.140	50	20x1.5	24	22	27	42.5	42.5	53.0	15.0	27.5	27.5	10.8	45.0	36.600	
SO NV 41C21E-15	028.2000.150	50	20x1.5	24	22	27	42.5	42.5	53.0	15.0	27.5	27.5	10.8	45.0	36.300	
Für Zollrohre		Pour tubes pouces						For inch tubes								
SO NV 41C21E-6,35	028.2000.063	50	10x1	12	14	19	29.0	29.0	41.0	10.0	20.0	20.0	4.0	5.5	10.300	
SO NV 41C21E-9,52	028.2000.095	50	14x1	17	19	24	37.0	37.0	45.0	12.0	24.0	24.0	6.5	14.0	20.600	
* SO NV 41C21E-12,7	028.2000.127	50	20x1.5	24	22	27	42.5	42.5	53.0	15.0	27.5	27.5	10.8	40.0	37.100	

Umrechnung für "d" bei Zollrohren:

6,35 = 1/4

9,52 = 3/8

12,7 = 1/2

Conversion de "d" pour tubes en pouces:

6,35 = 1/4

9,52 = 3/8

12,7 = 1/2

Conversion for "d" for inch tubes:

6,35 = 1/4

9,52 = 3/8

12,7 = 1/2

 D = \varnothing 20 mm \leq Anschlussgröße 8
 \varnothing 32 mm \geq Anschlussgröße 9,52

 D = \varnothing 20 mm \leq Dimension 8
 \varnothing 32 mm \geq Dimension 9,52

 D = \varnothing 20 mm \leq Dimension 8
 \varnothing 32 mm \geq Dimension 9,52

 B = \varnothing 16,5 mm \leq Anschlussgröße 8
 \varnothing 20,5 mm \geq Anschlussgröße 9,52

 B = \varnothing 16,5 mm \leq Dimension 8
 \varnothing 20,5 mm \geq Dimension 9,52

 B = \varnothing 16,5 mm \leq Dimension 8
 \varnothing 20,5 mm \geq Dimension 9,52

 d=Rohrassen- \varnothing

e=kleinste Bohrung

kv=Kenngröße für das Durchflussverhalten (l/min)

L=Mass in montiertem Zustand

*=mit reduziertem Klemmring

 d= \varnothing extérieur du tube

 e= \varnothing -min. de passage

kv=facteur d'écoulement (l/min)

L=après montage

*=avec bague de serrage de réduction

d=tube outside diameter

e=minimum bore

kv=flow factor (l/min)

L=installed length

*=with reduced compression ferrule

Feinregulier-Eckventil

mit Einschraubgewinde

Robinet-équerre de réglage fin

avec filetage mâle

Elbow fine regulating valve

with male adaptor thread

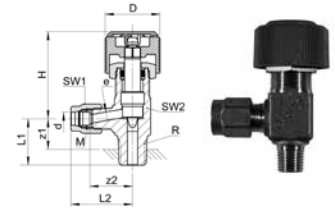
SO NV 41C21EB

Type -d -R	Mat.-Nr.	bar	M	SW1	SW2	L1	L2	D	H	z1	z2	e	kv	kg/100
Für metrische Rohre				Pour tubes métriques						For metric tubes				
R=Rohrgewinde (kegelig)				R=Filetage-gaz BSP (conique)						R=BSP thread (tapered)				
* SO NV 41C21EB-4-1/8	028.2100.060	50	10x1	12	14	19.0	27.5	26.0	46.0	11.0	20.0	3.4	4.5	9.500
* SO NV 41C21EB-5-1/8	028.2100.082	50	10x1	12	14	19.0	27.5	26.0	46.0	11.0	20.0	4.0	5.0	9.400
SO NV 41C21EB-6-1/8	028.2100.100	50	10x1	12	14	19.0	27.5	26.0	46.0	11.0	20.0	4.0	5.5	9.400
SO NV 41C21EB-6-1/4	028.2100.110	50	10x1	12	14	22.0	27.5	26.0	46.0	14.0	20.0	4.0	5.5	10.000
SO NV 41C21EB-8-1/8	028.2100.160	50	12x1	14	14	24.0	29.0	26.0	46.0	10.0	21.0	4.0	6.5	9.900
SO NV 41C21EB-8-1/4	028.2100.170	50	12x1	14	14	22.0	29.0	26.0	46.0	12.5	21.0	4.8	6.5	10.600
SO NV 41C21EB-10-1/4	028.2100.270	50	14x1	17	19	25.5	34.0	36.0	54.0	17.5	24.0	6.5	15.0	18.500
SO NV 41C21EB-12-1/4	028.2100.380	50	16x1	19	19	25.5	35.0	36.0	54.0	16.0	24.0	8.3	22.0	19.200
SO NV 41C21EB-12-3/8	028.2100.390	50	16x1	19	19	35.5	36.0	36.0	54.0	15.5	24.0	8.3	22.0	20.000
SO NV 41C21EB-14-1/2	028.2100.504	50	20x1.5	24	22	41.0	40.0	36.0	66.0	18.0	27.5	10.8	45.0	32.900
SO NV 41C21EB-15-1/2	028.2100.534	50	20x1.5	24	22	41.0	40.0	36.0	66.0	18.0	27.5	10.8	45.0	32.900

Für Zollrohre				Pour tubes pouces						For inch tubes				
SO NV 41C21EB-6,35-1/8	028.2100.135	50	10x1	12	14	19.0	27.5	26.0	46.0	11.0	20.0	4.0	5.5	9.400
SO NV 41C21EB-9,52-1/4	028.2100.230	50	14x1	17	19	25.5	34.0	36.0	54.0	16.0	24.0	6.5	14.0	19.200
* SO NV 41C21EB-12,7-1/2	028.2100.434	50	20x1.5	24	22	31.0	40.0	36.0	66.0	18.0	27.5	10.8	40.0	33.300

Umrechnung für "d" bei Zollrohren:

6,35 = 1/4

9,52 = 3/8

12,7 = 1/2

Conversion de "d" pour tubes en pouces:

6,35 = 1/4

9,52 = 3/8

12,7 = 1/2

Conversion for "d" for inch tubes:

6,35 = 1/4

9,52 = 3/8

12,7 = 1/2

d=Rohrassen-ø

e=kleinste Bohrung

kv=Kenngröße für das Durchflussverhalten (l/min)

L=Mass in montiertem Zustand

*=mit reduziertem Klemmring

d=ø extérieur du tube

e=ø-min. de passage

kv=facteur d'écoulement (l/min)

L=après montage

*=avec bague de serrage de réduction

d=tube outside diameter

e=minimum bore

kv=flow factor (l/min)

L=installed length

*=with reduced compression ferrule

Feinregulier-Eckventil

mit Einstellzapfen

Robinet-équerre de réglage fin

orientable

Elbow fine regulating valve

adjustable

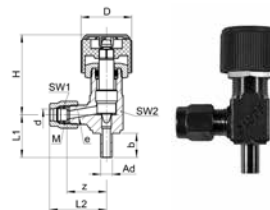
SO NV 41C21EL

Type -d -Ad	Mat.-Nr.	bar	M	SW1	SW2	L1	L2	D	H	b	z	e	kv	kg/100	
Für metrische Rohre			Pour tubes métriques					For metric tubes							
* SO NV 41C21EL-4-A6	028.2060.045	50	10x1	12	14	22.0	27.5	26.0	46.0	12.5	20.0	3.4	5.0	9.400	
* SO NV 41C21EL-5-A5	028.2060.053	50	10x1	12	14	22.0	27.5	26.0	46.0	12.5	20.0	4.0	5.5	9.400	
SO NV 41C21EL-6-A6	028.2060.060	50	10x1	12	14	22.0	27.5	26.0	46.0	12.5	20.0	4.0	6.0	9.400	
* SO NV 41C21EL-6-A8	028.2060.063	50	12x1	14	14	22.0	29.0	26.0	46.0	12.5	21.0	4.5	7.5	10.600	
SO NV 41C21EL-8-A8	028.2060.080	50	12x1	14	14	22.0	29.0	26.0	46.0	12.5	21.0	5.0	8.0	10.600	

Für Zollrohre

Pour tubes pouces

For inch tubes

SO NV 41C21EL-6,35-A6	028.2060.067	50	10x1	12	14	22.0	27.5	26.0	46.0	12.5	20.0	4.0	6.0	9.400
-----------------------	--------------	----	------	----	----	------	------	------	------	------	------	-----	-----	-------

Umrechnung für "d" bei Zollrohren:

6,35 = 1/4

Conversion de "d" pour tubes en pouces:

6,35 = 1/4

Conversion for "d" for inch tubes:

6,35 = 1/4

d=Rohrassens-ø

e=kleinste Bohrung

kv=Kenngröße für das Durchflussverhalten (l/min)

L=Mass in montiertem Zustand

*=mit reduziertem Klemmring

d=ø extérieur du tube

e=ø-min. de passage

kv=facteur d'écoulement (l/min)

L=après montage

*=avec bague de serrage de réduction

d=tube outside diameter

e=minimum bore

kv=flow factor (l/min)

L=installed length

*=with reduced compression ferrule

Kegelrückschlagventil
Soupape de retenue à siège conique
Taper seat non-return valve

**SO CV 43A21 /
A30/A40**

12

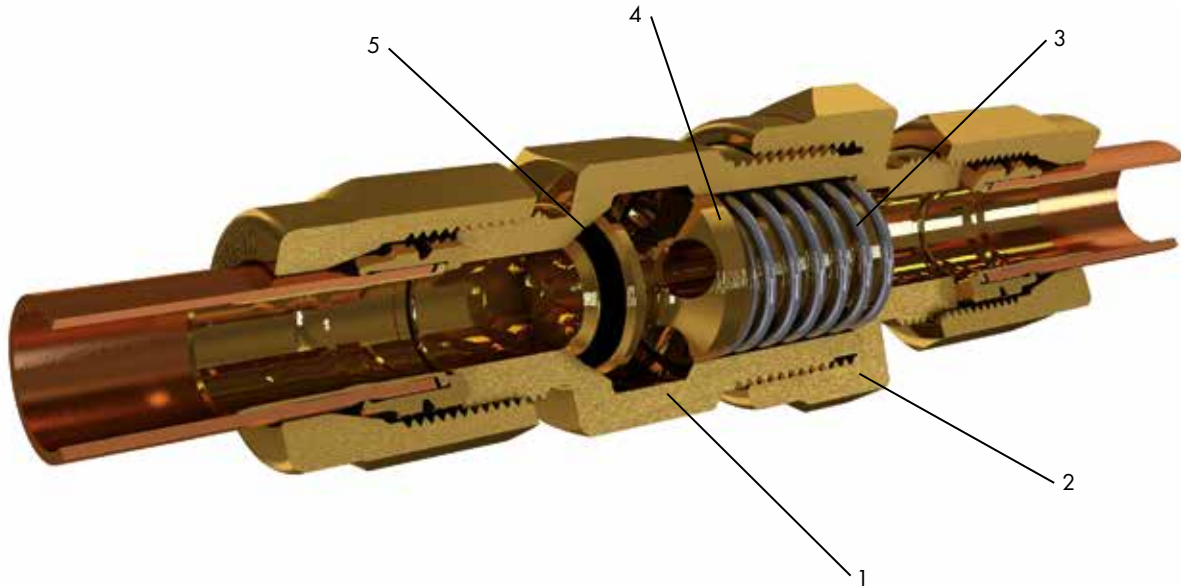

Nr. No. No.	Bezeichnung Désignation Description	Material Matériau Material	Nr. No. No.	Bezeichnung Désignation Description	Material Matériau Material	Nr. No. No.	Bezeichnung Désignation Description	Material Matériau Material
1	Ventilkegelführung Guidage cône de soupape Valve cone guide	Messing Laiton Brass	3*	Druckfeder Ressort de compression Compression spring	1.4401	5*	Dichtung Joint Seal	NBR
2	Ventilmutter Écrou de soupape Valve nut	Messing Laiton Brass	4	Ventilkegel Cône de soupape Valve cone	Messing Laiton Brass			

Spezifikationen

Betriebsdruck (PN): 50 bis 100 bar
 Temperatur: -20°C bis +80°C
 Öffnungsdruck: 0.2 bar ± 20 %
 Sicherheitsfaktor: 1.5-fach

Merkmale

- Funktion: Rückflussverhinderer
- Einsatz: Luft, Wasser, Öle und Flüssiggase (Beständigkeit Dichtung beachten)
- Material: Messing CW617N (CuZn40Pb2)
- Besonderes: strömungsgünstige Konstruktion, Druckstöße werden gedämpft

*** Optionen**

- Nr. 3 - Druckfeder: Öffnungsdruck 0.5, 1, 2, 3 bar ± 20 %
- Nr. 5 - Dichtung: EPDM, FPM
- Varianten: mit Übergangsmuffe SO 40030 oder Übergangsnippel SO 40040

Spécifications

Pression de service (PN): 50 à 100 bar
 Température: -20°C à +80°C
 Pression d'ouverture: 0.2 bar ± 20 %
 Facteur de sécurité: 1.5 fois

Caractéristiques

- Fonction: clapet anti-retour
- Application: air, eau, huiles et gaz liquéfiés (tenir compte de la résistance de l'étanchéité)
- Matériau: laiton CW617N (CuZn40Pb2)
- Particularités: conception favorisant l'écoulement, amortit les coups de bélier

*** Options**

- No. 3 - Ressort de compression: pression d'ouverture 0.5, 1, 2, 3 bar ± 20 %
- No. 5 - Joint: EPDM, FPM
- Autres versions: avec adaptateur femelle SO 40030 ou mâle SO 40040

Specifications

Working pressure (PN): 50 to 100 bar
 Temperature: -20°C to +80°C
 Opening pressure: 0.2 bar ± 20 %
 Safety factor: 1.5 times

Characteristics

- Function: check valve
- Uses: air, water, oils and liquid gases (check resistance of seal)
- Material: brass CW617N (CuZn40Pb2)
- Special: flow-optimised design, damps water hammer

*** Options**

- No. 3 - Compression spring: opening pressure 0.5, 1, 2, 3 bar ± 20 %
- No. 5 - Seal: EPDM, FPM
- Other versions: with female SO 40030 or male adaptor SO 40040

Durchflussdiagramm

Der Druckabfall nimmt mit zunehmendem Durchfluss überproportional zu.

Courbe de débit

La perte de pression augmente disproportionnellement avec plus de débit.

Flow rate

The pressure drop increases disproportionately with increasing flow rate.

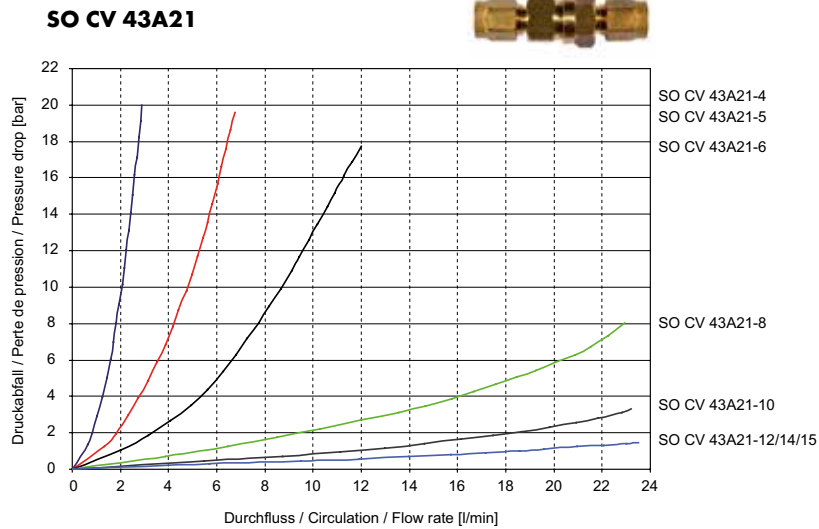

Öffnungsdruckdiagramm

Der Öffnungsdruck bewegt sich im blau skizzierten Bereich. Das Ventil schliesst im rot skizzierten Bereich.

Courbe de pression d'ouverture

La pression d'ouverture se trouve dans la zone indiquée en bleu. La vanne se ferme dans la zone indiquée en rouge.

Opening pressure diagram

The opening pressure ranges within the blue section. The valve closes within the red section.

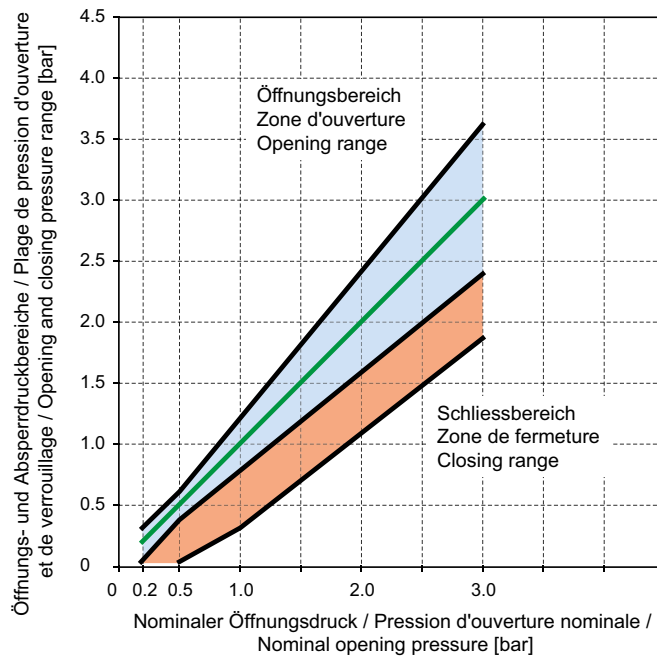

Sonderausführungen

siehe Kapitelübersicht

Exécutions en option

voir aperçu du chapitre

Optional services

see chapter overview

Kegelrückschlagventil

Soupape de retenue à siège conique

Taper seat non-return valve

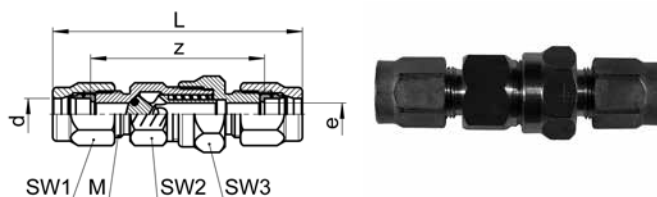

SO CV 43A21

Type -d	Mat.-Nr.	bar	M	SW1	SW2	SW3	L	z	e	kg/100	
Für metrische Rohre	Pour tubes métriques			For metric tubes							
* SO CV 43A21-4	028.3000.040	100	10x1	12	12	14	53.5	38.5	3.4	4.500	
* SO CV 43A21-5	028.3000.050	100	10x1	12	12	14	53.5	38.5	3.8	4.400	
SO CV 43A21-6	028.3000.060	100	10x1	12	12	14	54.0	39.0	3.8	4.300	
SO CV 43A21-8	028.3000.080	100	12x1	14	14	17	63.0	47.0	5.8	6.300	
SO CV 43A21-10	028.3000.100	64	14x1	17	19	22	71.0	51.0	7.5	12.000	
* SO CV 43A21-12	028.3000.120	50	20x1.5	24	24	27	82.5	58.0	10.0	23.800	
* SO CV 43A21-13	028.3000.130	50	20x1.5	24	24	27	82.5	58.0	11.0	23.600	
SO CV 43A21-14	028.3000.140	50	20x1.5	24	24	27	82.5	58.0	11.0	23.100	
SO CV 43A21-15	028.3000.150	50	20x1.5	24	24	27	82.5	58.0	11.0	23.000	
Für Zollrohre	Pour tubes pouces			For inch tubes							
SO CV 43A21-6,35	028.3000.063	100	10x1	12	12	14	54.0	39.0	3.8	4.300	
SO CV 43A21-9,52	028.3000.095	64	14x1	17	19	22	71.0	47.0	7.5	12.000	
* SO CV 43A21-12,7	028.3000.127	50	20x1.5	24	24	27	82.5	58.0	11.0	23.700	

Umrechnung für "d" bei Zollrohren:

6,35 = 1/4

9,52 = 3/8

12,7 = 1/2

Conversion de "d" pour tubes en pouces:

6,35 = 1/4

9,52 = 3/8

12,7 = 1/2

Conversion for "d" for inch tubes:

6,35 = 1/4

9,52 = 3/8

12,7 = 1/2

Kegelrückschlagventil

mit Übergangsmuffe SO 40030

Soupape de retenue à siège conique

avec adaptateur femelle SO 40030

Taper seat non-return valve

with female adaptor SO 40030

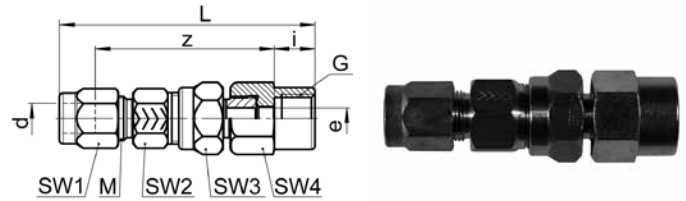

SO CV 43A30

Type -d-G	Mat.-Nr.	bar	M	SW1	SW2	SW3	SW4	L	i	z	e	kg/100
G=Rohrgewinde (zylindrisch)				G=Filetage-gaz BSP (cylindrique)				G=BSP thread (parallel)				
* SO CV 43A30-4-1/4	028.3300.065	100	10x1	12	12	14	17	60.0	11.0	41.5	3.4	5.080
SO CV 43A30-6-1/8	028.3300.100	100	10x1	12	12	14	14	59.0	10.0	41.5	3.8	4.110
SO CV 43A30-6-1/4	028.3300.110	100	10x1	12	12	14	17	60.0	11.0	41.5	3.8	4.970
SO CV 43A30-6-3/8	028.3300.120	100	10x1	12	12	14	22	61.0	12.0	41.5	3.8	7.240
SO CV 43A30-8-1/8	028.3300.160	100	12x1	14	14	17	17	65.5	10.0	47.5	5.8	6.410
SO CV 43A30-8-1/4	028.3300.170	100	12x1	14	14	17	17	67.5	11.0	48.5	5.8	6.160
SO CV 43A30-8-3/8	028.3300.180	100	12x1	14	14	17	22	67.5	12.0	47.5	5.8	8.400
SO CV 43A30-10-1/4	028.3300.270	64	14x1	17	19	22	17	74.5	11.0	53.5	7.5	8.530
SO CV 43A30-10-3/8	028.3300.280	64	14x1	17	19	22	22	76.5	12.0	54.5	7.5	11.200
* SO CV 43A30-12-3/8	028.3300.390	50	20x1.5	24	24	27	24	86.5	12.0	61.0	10.0	17.780
* SO CV 43A30-12-1/2	028.3300.400	50	20x1.5	24	24	27	27	87.5	14.0	61.0	10.0	19.810
* SO CV 43A30-12-3/4	028.3300.405	50	20x1.5	24	24	27	32	90.5	17.0	61.0	10.0	23.660
SO CV 43A30-14-1/2	028.3300.504	50	20x1.5	24	24	27	27	87.5	14.0	61.0	11.0	19.590
SO CV 43A30-15-1/2	028.3300.534	50	20x1.5	24	24	27	27	87.5	14.0	61.0	11.0	19.270

Kegelrückschlagventil

mit Übergangsnippel SO 40040

Soupape de retenue à siège conique

avec adaptateur mâle SO 40040

Taper seat non-return valve

with male adaptor SO 40040

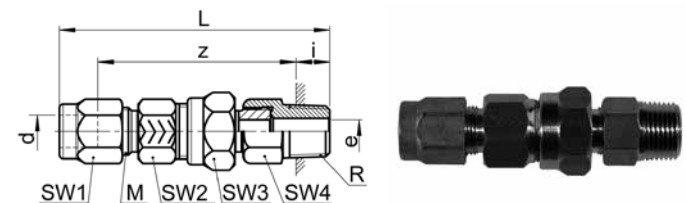

SO CV 43A40

Type -d-R	Mat.-Nr.	bar	M	SW1	SW2	SW3	SW4	L	i	z	e	kg/100
R=Rohrgewinde (kegelig)				R=Filetage-gaz BSP (conique)				R=BSP thread (tapered)				
* SO CV 43A40-4-1/4	028.3400.065	100	10x1	12	12	14	14	58.5	8.0	43.0	3.4	4.400
SO CV 43A40-6-1/8	028.3400.100	100	10x1	12	12	14	12	54.0	5.0	41.5	3.8	3.240
SO CV 43A40-6-1/4	028.3400.110	100	10x1	12	12	14	14	58.5	8.0	43.0	3.8	4.300
SO CV 43A40-6-3/8	028.3400.120	100	10x1	12	12	14	17	57.0	8.0	41.5	3.8	5.450
SO CV 43A40-8-1/8	028.3400.160	100	12x1	14	14	17	14	61.0	5.0	48.0	5.0	4.600
SO CV 43A40-8-1/4	028.3400.170	100	12x1	14	14	17	14	65.0	8.0	49.0	5.8	5.100
SO CV 43A40-8-3/8	028.3400.180	100	12x1	14	14	17	17	64.5	8.0	48.5	5.8	6.600
SO CV 43A40-10-1/4	028.3400.270	64	14x1	17	19	22	17	73.0	8.0	55.0	7.5	8.150
SO CV 43A40-10-3/8	028.3400.280	64	14x1	17	19	22	17	72.5	8.0	54.5	7.5	8.880
* SO CV 43A40-12-3/8	028.3400.390	50	20x1.5	24	24	27	24	82.5	8.0	62.0	10.0	16.450
* SO CV 43A40-12-1/2	028.3400.400	50	20x1.5	24	24	27	24	83.5	10.0	61.0	10.0	17.110
* SO CV 43A40-12-3/4	028.3400.405	50	20x1.5	24	24	27	27	85.0	12.0	60.5	10.0	20.930
SO CV 43A40-14-1/2	028.3400.504	50	20x1.5	24	24	27	24	83.5	10.0	61.0	11.0	16.890
SO CV 43A40-15-1/2	028.3400.534	50	20x1.5	24	24	27	24	83.5	10.0	61.0	11.0	17.290

d=Rohrassen- \emptyset
 e=kleinste Bohrung
 L=Mass in montiertem Zustand
 *=mit reduziertem Klemmring

d= \emptyset extérieur du tube
 e= \emptyset -min. de passage
 L=après montage
 *=avec bague de serrage de réduction

d=tube outside diameter
 e=minimum bore
 L=installed length
 *=with reduced compression ferrule

Doppelkugelrückschlagventil

für Heizöltanks

Soupape de retenue à deux billes

pour des citernes à mazout

Double ball valve

for oil tanks

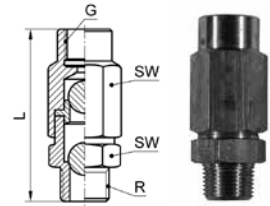

SO CV 43B05

Type -G-R	Mat.-Nr.	bar	SW	L	kg/100
G=Rohrgewinde (zylindrisch)	G=Filetage-gaz BSP (cylindrique)			G=BSP thread (parallel)	
R=Rohrgewinde (kegelig)	R=Filetage-gaz BSP (conique)			R=BSP thread (tapered)	
SO CV 43B05-1/4-3/8	028.9403.106	10	22	60.0	6.900

Doppelkugelrückschlagventil

für Heizöltanks

Soupape de retenue à deux billes

pour des citernes à mazout

Double ball valve

for oil tanks

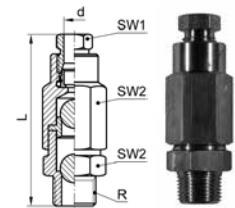

SO CV 43B01

Type -d-R	Mat.-Nr.	bar	SW1	SW2	L	kg/100
R=Rohrgewinde (kegelig)	R=Filetage-gaz BSP (conique)				R=BSP thread (tapered)	
SO CV 43B01-6-3/8	028.9403.120	10	14	22	69.0	8.300
SO CV 43B01-8-3/8	028.9403.180	10	14	22	69.0	8.300

Doppelschutzventil

für Ölfeuerungsanlagen

Vanne à double protection

pour installations de chauffage

Double action valve

for oil firing installation

SO CV 43C21

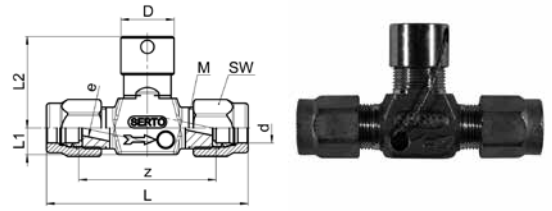

Type -d	Mat.-Nr.	bar	M	SW	L	L1	L2	D	z	e	kg/100
★ SO CV 43C21-6	028.9391.060	10	12x1	14	62.0	9.0	31.0	18.0	46.0	4.5	10.600
SO CV 43C21-8	028.9391.080	10	12x1	14	62.0	9.0	31.0	18.0	46.0	5.0	10.300
SO CV 43C21-10	028.9391.100	10	14x1	17	74.5	9.0	31.0	18.0	54.5	5.0	21.800
SO CV 43C21-12	028.9391.120	10	16x1	19	97.0	9.0	31.0	18.0	72.5	5.0	21.800
★ SO CV 43C21-8/6 SET	028.9391.086	10	12x1	14	62.0	9.0	31.0	18.0	46.0	4.5	11.300

Anwendungsbeispiele:

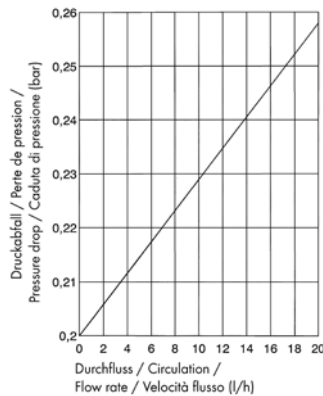

Die Kurve zeigt Richtwerte

Exemples d'utilisation:

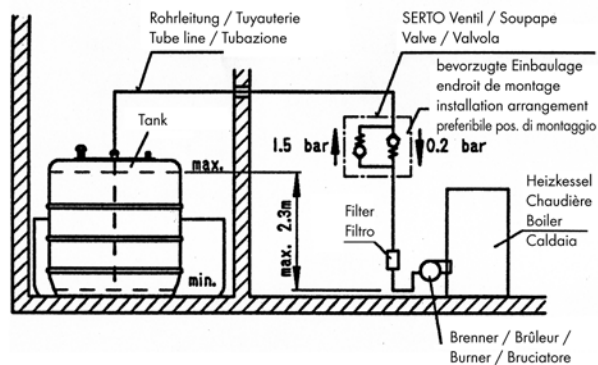

Données approximatives

Sample combinations:

Guideline values

Für Ölfeuerungsanlagen

Funktion:

Unter Federvorspannung geschlossen – der freie Durchgang ergibt sich über ein Vakuum, welches von der Brennerpumpe erzeugt wird. Ohne Saugwirkung schliesst das Ventil selbstständig. Eine zusätzliche Sicherheit ist durch die integrierte Druckentlastung gegeben. Ein Druckanstieg über 1,5 bar durch Erwärmung der eingeschlossenen Ölsäule ist nicht möglich. Das Heizöl kann zum Tank zurückfließen.

Das SERTO Doppelschutzventil wird ausschließlich in Ölfeuerungsanlagen, welche im Einstrangsystem betrieben werden, eingesetzt.

Merkmale:

- Verhindert Öl-Abhebern
- Integrierte Druckentlastung
- Öffnet bei 0,2 bar Vakuum
- Einjustiert und plombiert

d=Rohrassen-ø
L=Mass im montierten Zustand
e=kleinste Bohrung
*=mit reduziertem Klemmring

Pour installations de chauffage

Fonction:

La vanne est fermée par un ressort précontraint, le libre passage est donné par une dépression générée par la pompe du brûleur. Sans aspiration, la vanne se ferme d'elle même. Une sécurité supplémentaire est apportée par la détente de pression intégrée. Une montée de pression dépassant 1,5 bar par suite d'échauffement de la colonne de mazout retenue n'est pas possible. L'huile de chauffage peut retourner vers le réservoir.

La vanne SERTO à double protection est utilisée exclusivement dans des installations de chauffage en une ligne.

Caractéristiques:

- Evite le siphonnage du mazout
- Vidange à pression intégrée
- Ouverture avec un vide de 0,2 bar
- Ajusté et plombé

d=ø extérieur du tube
L=après montage
e=ø-min. de passage
*=avec bague de serrage de réduction

For oil firing installation

Function:

Closed by spring pre-tension, the valve is opened by a vacuum which is generated by the burner pump. When the suction action ceases, the valve will close automatically. An additional safety factor is provided by the integrated pressure-relief function. A pressure build-up above 1,5 bar caused by heating up of the contained oil column is not possible. The fuel oil can flow back into the tank.

The SERTO double action valve is used exclusively in oil firing installations which are operated on the single-line principle.

Characteristics:

- Prevents self-siphonage of the oil
- Integrated pressure relief
- Opens at a vacuum of 0,2 bar
- Adjusted and sealed

d=tube outside diameter
L=installed length
e=minimum bore
*=with reduced compression ferrule

Schwenkverschraubung

mit Drossel-Ventil

Coude banjo

avec limiteur de débit

Single banjo

with throttle valve

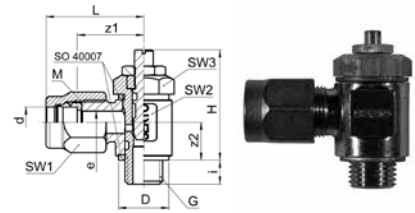
SO 47624

Type -d-G	Mat.-Nr.	bar	M	SW1	SW2	SW3	L	D	H	i	z1	z2	e	kv	kg/100
Für metrische Rohre															
G=Rohrgewinde (zylindrisch)															
* SO 47624-3-1/8	028.7600.040	16	8x1	10	14	14	24.0	13.4	26.0	6.5	17.5	10.0	2.5	3.0	4.000
SO 47624-4-1/8	028.7600.060	16	8x1	10	14	14	23.5	13.4	26.0	6.5	17.5	10.0	3.4	3.0	3.800
SO 47624-5-1/8	028.7600.082	16	8x1	10	14	14	24.0	13.4	26.0	6.5	17.5	10.0	3.5	3.0	3.700
SO 47624-6-1/8	028.7600.100	16	10x1	12	14	14	25.0	13.4	26.0	6.5	17.5	10.0	3.5	3.0	4.300
* SO 47624-6-1/4	028.7600.110	16	12x1	14	19	19	29.0	17.9	31.5	8.0	21.0	13.5	4.5	6.0	8.600
SO 47624-8-1/8	028.7600.160	16	12x1	14	14	14	25.5	13.4	31.5	6.5	17.5	10.0	3.5	3.0	4.600
SO 47624-8-1/4	028.7600.170	16	12x1	14	19	19	29.0	17.9	31.5	8.0	21.0	13.5	5.0	6.0	8.400
SO 47624-10-1/4	028.7600.270	16	14x1	17	19	19	32.0	17.9	31.5	8.0	21.0	13.5	5.0	6.0	9.000
Für Zollrohre															
SO 47624-6,35-1/8	028.7600.135	16	10x1	12	14	14	25.0	13.4	26.0	6.5	17.5	10.0	3.5	3.0	4.200
SO 47624-9,52-1/4	028.7600.230	16	14x1	17	19	19	31.0	17.9	31.5	8.0	21.0	13.5	5.0	6.0	9.100

Umrechnung für "d" bei Zollrohren:
 6,35 = 1/4
 9,52 = 3/8

Conversion de "d" pour tubes en pouces:
 6,35 = 1/4
 9,52 = 3/8

Conversion for "d" for inch tubes:
 6,35 = 1/4
 9,52 = 3/8

Temperatur -20°C/+80°C

Température -20°C/+80°C

Temperature -20°C/+80°C

Dieses Drossel-Ventil dient zur Regulierung von Luftströmen in beiden Richtungen. Die Spindel-fixierung mittels Kontermutter garantiert, dass sich die Spindel auch bei Vibration nicht verstellt.

Ce limiteur de débit sert au réglage de l'écoulement d'air dans les deux sens. La fixation de la broche à l'aide d'un contre-écrou garantit la stabilité du réglage même en cas de vibrations.

This throttle valve can be used for regulating air flow in both directions. The spindle fixture via counter-nut assures that spindle cannot shift, even due to vibration.

Technische Hinweise:

Körper, Ventileinsatz und Anschlüsse aus Messing. O-Ring aus NBR.

Données techniques:

Soupape, pointeau et écrous en laiton. Joint torique en matière NBR caoutchouc.

Technical notes:

Valve body, valve components and connections of brass. O-ring of NBR.

d=Rohraussen-ø
 e=kleinste Bohrung
 kv=Kenngröße für das Durchflussverhalten (l/min)
 L=Mass in montiertem Zustand
 *=mit reduziertem Klemmring

d=ø extérieur du tube
 e=ø-min. de passage
 kv=facteur d'écoulement (l/min)
 L=après montage
 *=avec bague de serrage de réduction

d=tube outside diameter
 e=minimum bore
 kv=flow factor (l/min)
 L=installed length
 *=with reduction compression ferrule

Schwenkverschraubung

mit Drossel-Rückschlagventil

Coude banjo

avec clapet anti-retour limiteur de débit

Single banjo

with throttle non-return valve

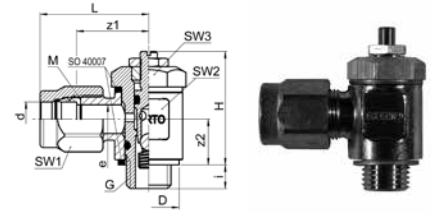
SO 47724

Type -d-G	Mat.-Nr.	bar	M	SW1	SW2	SW3	L	D	H	i	z1	z2	e	kv	kg/100
Für metrische Rohre															
G=Rohrgewinde (zylindrisch)															
* SO 47724-3-1/8	028.7700.040	16	8x1	10	14	14	24.0	13.4	26.0	6.5	17.5	10.0	2.5	3.0	4.000
SO 47724-4-1/8	028.7700.060	16	8x1	10	14	14	23.5	13.4	26.0	6.5	17.5	10.0	3.4	3.0	3.800
SO 47724-5-1/8	028.7700.082	16	8x1	10	14	14	24.0	13.4	26.0	6.5	17.5	10.0	3.5	3.0	3.700
SO 47724-6-1/8	028.7700.100	16	10x1	12	14	14	25.0	13.4	26.0	6.5	17.5	10.0	3.5	3.0	4.300
* SO 47724-6-1/4	028.7700.110	16	12x1	14	19	19	29.0	17.9	31.5	8.0	21.0	13.5	4.5	6.0	8.600
SO 47724-8-1/8	028.7700.160	16	12x1	14	14	14	25.5	13.4	26.0	6.5	17.5	10.0	3.5	3.0	4.600
SO 47724-8-1/4	028.7700.170	16	12x1	14	19	19	29.0	17.9	31.5	8.0	21.0	13.5	5.0	6.0	8.400
SO 47724-10-1/4	028.7700.270	16	14x1	17	19	19	32.0	17.9	33.5	8.0	21.0	13.5	5.0	6.0	9.000

Für Zollrohre

Pour tubes pouces

For inch tubes

SO 47724-6,35-1/8	028.7700.135	16	10x1	12	14	14	25.0	13.4	26.0	6.5	17.5	10.0	3.5	3.0	4.200
SO 47724-9,52-1/4	028.7700.230	16	14x1	17	19	19	31.0	17.9	31.5	8.0	21.0	13.5	5.0	6.0	9.100

Umrechnung für "d" bei Zollrohren:

$$6,35 = 1/4$$

$$9,52 = 3/8$$

Conversion de "d" pour tubes en pouces:

$$6,35 = 1/4$$

$$9,52 = 3/8$$

Conversion for "d" for inch tubes:

$$6,35 = 1/4$$

$$9,52 = 3/8$$

Temperatur: -20°C /+ 80°C

Température: -20°C/+ 80°C

Temperature: -20°C/+80°C

Dieses Drossel-Rückschlagventil wird dort eingesetzt, wo unterschiedliche Geschwindigkeiten von Luftströmen benötigt werden. Die Spindelfixierung mittels Kontermutter garantiert, dass sich die Spindel auch bei Vibration nicht verstell.

Ce clapet anti-retour limiteur de débit est utilisé lorsque les écoulements d'air doivent avoir une vitesse différente. La fixation de la broche à l'aide d'un contre-écrou garantit la stabilité du réglage même en cas de vibrations.

This throttle non-return valve is installed where various air flow rates are required. The spindle fixture via counter-nut assures that spindle cannot shift, even due to vibration.

Technische Hinweise:

Körper, Ventileinsatz und Anschlüsse aus Messing, O-Ring aus NBR, Feder aus nichtrostendem Stahl, Kugel aus Polyurethan.

Données techniques:

Soupape, pointeau et écrous en laiton, joint torique en NBR, ressort en acier inoxydable, bille en polyuréthane.

Technical notes:

Valve body, valve components and connections of brass, O-ring of NBR, spring of stainless steel, ball of polyurethane.

d=Rohraussen-ø

e=kleinste Bohrung

kv=Kenngröße für das Durchflussverhalten (l/min)

L=Mass in montiertem Zustand

*=mit reduziertem Klemmring

d=ø extérieur du tube

e=ø-min. de passage

kv=facteur d'écoulement (l/min)

L=après montage

*=avec bague de serrage de réduction

d=tube outside diameter

e=minimum bore

kv=flow factor (l/min)

L=installed length

*=with reduction compression ferrule

Mini-Kugelhahn

mit Innengewinde

Mini robinet à bille

avec taraudage femelle

Mini-Ball valve

with female thread

SO BV 48A00

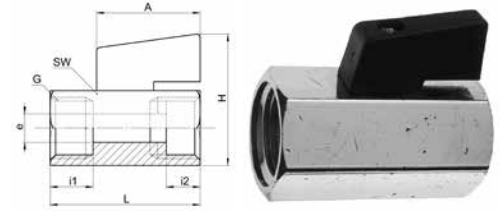

12

Type -G	Mat.-Nr.	bar	SW	L	A	H	i1	i2	e	kv	kg/100
G=Rohrgewinde (zylindrisch)	G=Filetage-gaz BSP (cylindrique)	G=BSP thread (parallel)									
SO BV 48A00-1/8	TKH.478.5011	10	21	39.0	30.0	37.5	9.0	10.0	8.0	45.0	9.900
SO BV 48A00-1/4	TKH.478.5012	10	21	39.0	30.0	37.5	9.0	10.2	8.0	67.0	9.500
SO BV 48A00-3/8	TKH.478.5013	10	21	42.0	30.0	37.5	12.0	10.0	8.0	67.0	8.700
SO BV 48A00-1/2	TKH.478.5014	10	24	47.0	30.0	41.5	12.0	11.5	10.0	90.0	13.200
SO BV 48A00-3/4	TKH.478.5015	10	30	54.0	30.0	46.5	14.5	12.0	13.5	130.0	19.300

Spezifikationen

Betriebsdruck (PN): 10 bar
 Temperatur: -10°C/+90°C
 Sicherheitsfaktor: 1.5-fach

Merkmale

Breite Anwendungsvielfalt: Ideal für Wasser, Luft, Mineralöl, für Sanitär, Heizung, Apparatebau.
 Material d. Körpers: Messing CW617N
 Kugeldichtung: PTFE, Spindeldichtung: NBR

Dienstleistungsoptionen auf Anfrage

Spécifications

Pression de service (PN): 10 bar
 Température: -10°C/+90°C
 Facteur de sécurité: 1.5 fois

Caractéristiques

Champ d'application étendu: Idéal pour l'eau, l'air, l'huile minérale, pour l'industrie sanitaire, le chauffage et la construction des appareils.
 Matériau corps: Laiton CW617N
 Joint du bille: PTFE, Joint du tige: NBR

Options de service sur demande

Specifications

Working pressure (PN): 10 bar
 Temperature: -10°C/+90°C
 Safety factor: 1.5 times

Characteristics

Large field of application: Ideal for water, air, mineral oil, for sanitary purposes, heating industry and the construction of apparatus.
 Body material: Brass CW 617N
 Ball gasket: PTFE, Spindle O-ring: NBR

Optional services on request

A=Grifflänge
 e=kleinste Bohrung
 kv=Kenngröße für das Durchflussverhalten (l/min)
 i=Gewindelänge

A=longueur de la manette
 e=ø-min. de passage
 kv=facteur d'écoulement (l/min)
 i=longueur du filetage

A=length of the handle
 e=minimum bore
 kv=flow factor (l/min)
 i=threads length

Mini-Kugelhahn

mit Innen-/Aussengewinde

Mini robinet à bille

avec taraudage femelle-filetage mâle

Mini-Ball valve

with female/male thread

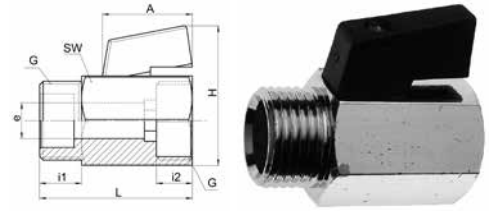

SO BV 48A05

Type -G	Mat.-Nr.	bar	SW	L	A	H	i1	i2	e	kv	kg/100
G=Rohrgewinde (zylindrisch)	G=Filetage-gaz BSP (cylindrique)	G=BSP thread (parallel)									
SO BV 48A05-1/8	TKH.478.5111	10	21	39.0	30.0	37.5	9.0	10.0	8.0	45.0	8.400
SO BV 48A05-1/4	TKH.478.5112	10	21	39.0	30.0	37.5	9.0	10.0	8.0	67.0	8.100
SO BV 48A05-3/8	TKH.478.5113	10	21	40.0	30.0	37.5	10.0	10.0	8.0	67.0	7.800
SO BV 48A05-1/2	TKH.478.5114	10	24	45.0	30.0	41.5	10.0	11.5	10.0	90.0	12.000
SO BV 48A05-3/4	TKH.478.5115	10	30	51.0	30.0	46.5	14.0	12.0	12.0	130.0	17.800

Spezifikationen

Betriebsdruck (PN): 10 bar
 Temperatur: -10°C/+90°C
 Sicherheitsfaktor: 1.5-fach

Merkmale

Breite Anwendungsvielfalt: Ideal für Wasser, Luft, Mineralöl, für Sanitär, Heizung, Apparatebau.
 Material d. Körpers: Messing CW617N
 Kugeldichtung: PTFE, Spindeldichtung: NBR

Dienstleistungsoptionen auf Anfrage

Spécifications

Pression de service (PN): 10 bar
 Température: -10°C/+90°C
 Facteur de sécurité: 1.5 fois

Caractéristiques

Champ d'application étendu: Idéal pour l'eau, l'air, l'huile minérale, pour l'industrie sanitaire, le chauffage et la construction des appareils.
 Matériau corps: Laiton CW617N
 Joint du bille: PTFE, Joint du tige: NBR

Options de service sur demande

Specifications

Working pressure (PN): 10 bar
 Temperature: -10°C/+90°C
 Safety factor: 1.5 times

Characteristics

Large field of application: Ideal for water, air, mineral oil, for sanitary purposes, heating industry and the construction of apparatus.
 Body material: Brass CW 617N
 Ball gasket: PTFE, Spindle O-ring: NBR

Optional services on request

A=Grifflänge
 e=kleinste Bohrung
 kv=Kenngröße für das Durchflussverhalten (l/min)
 i=Gewindelänge

A=longueur de la manette
 e=ø-min. de passage
 kv=facteur d'écoulement (l/min)
 i=longueur du filetage

A=length of the handle
 e=minimum bore
 kv=flow factor (l/min)
 i=threads length

Mini-Kugelhahn

mit Aussengewinde

Mini robinet à bille

avec filetage mâle

Mini-Ball valve

with male thread

SO BV 48A10

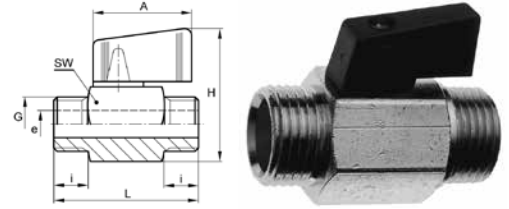

Type -G	Mat.-Nr.	bar	SW	L	A	H	i	e	kv	kg/100
G=Rohrgewinde (zylindrisch)	G=Filetage-gaz BSP (cylindrique)	G=BSP thread (parallel)								
SO BV 48A10-1/4	TKH.478.5212	10	21	40.5	30.0	37.5	9.0	8.0	67.0	8.100
SO BV 48A10-3/8	TKH.478.5213	10	21	41.0	30.0	37.5	9.0	8.0	67.0	7.800
SO BV 48A10-1/2	TKH.478.5214	10	24	50.0	30.0	41.5	11.5	10.0	90.0	12.000

Spezifikationen

Betriebsdruck (PN): 10 bar
 Temperatur: -10°C/+90°C
 Sicherheitsfaktor: 1.5-fach

Merkmale

Breite Anwendungsvielfalt: Ideal für Wasser, Luft, Mineralöl, für Sanitär, Heizung, Apparatebau.
 Material d. Körpers: Messing CW617N
 Kugeldichtung: PTFE, Spindeldichtung: NBR

Dienstleistungsoptionen auf Anfrage

Spécifications

Pression de service (PN): 10 bar
 Température: -10°C/+90°C
 Facteur de sécurité: 1.5 fois

Caractéristiques

Champ d'application étendu: Idéal pour l'eau, l'air, l'huile minérale, pour l'industrie sanitaire, le chauffage et la construction des appareils.
 Matériau corps: Laiton CW617N
 Joint du bille: PTFE, Joint du tige: NBR

Options de service sur demande

Specifications

Working pressure (PN): 10 bar
 Temperature: -10°C/+90°C
 Safety factor: 1.5 times

Characteristics

Large field of application: Ideal for water, air, mineral oil, for sanitary purposes, heating industry and the construction of apparatus.
 Body material: Brass CW 617N
 Ball gasket: PTFE, Spindle O-ring: NBR

Optional services on request

Regulier- / Feinregulierventil
Robinet de réglage / réglage fin
Regulating / fine regulating valve

SO NV 01A21
SO NV 01C21

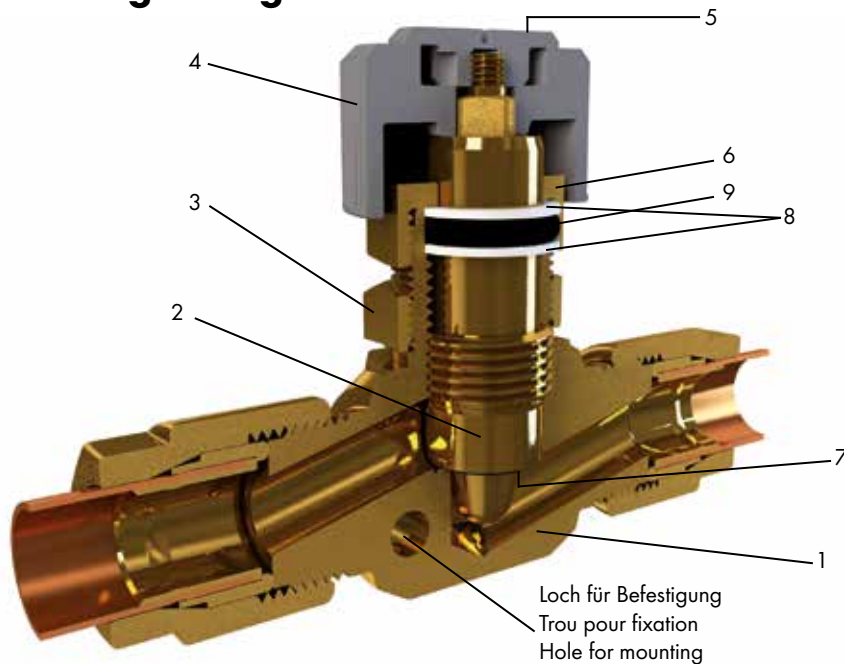

Nr. No. No.	Bezeichnung Désignation Description	Material Matériau Material	Nr. No. No.	Bezeichnung Désignation Description	Material Matériau Material	Nr. No. No.	Bezeichnung Désignation Description	Material Matériau Material
1	Ventilkörper Corps cône de soupape Valve body	Messing Laiton Brass	4	Handrad (grau) Manche (gris) Handwheel (grey)	Polyamid Polyamide Polyamide	7*	Dichtung Joint Seal	NBR/PTFE
2	Ventilspindel Tige de soupape Valve spindle	Messing Laiton Brass	5*	Ventilschild (grau) Plaque indicatrice (gris) Valve label (grey)	Polyamid Polyamide Polyamide	8	Dichtungs-Set Set des joints Set of Seals	PVDF
3	Kontermutter Contre-écrou Counter nut	Messing Laiton Brass	6*	Ventilkappe Bouchon de soupape Valve cap	Messing Laiton Brass	9	Dichtung Joint Seal	NBR

Spezifikationen

Betriebsdruck (PN): 50 bar
 Temperatur: -20°C bis +80°C
 Sicherheitsfaktor: 1.5-fach

Merkmale

- Funktion: Regulier- und Absperrventil
- Einsatz: Luft, Wasser, Öle und Flüssiggase (Beständigkeit Dichtung beachten)
- Material: Messing CW617N (CuZn40Pb2)
- Besonderes: kompakte Abmessungen, hohe Zuverlässigkeit

*** Optionen**

- Nr. 5 - Ventilschild: wahlweise auch in den Farben blau, rot, grün, siehe VSD SO NV
- Nr. 6 - Drehmoment für Ventilkappe bei Schalttafelmontage = 3.4 Nm
- Nr. 7 - Dichtung: EPDM, FKM
- Varianten: mit Übergangsmuffe SO 00030 oder Übergangsnippel SO 00040

Spécifications

Pression de service (PN): 50 bar
 Température: -20°C à +80°C
 Facteur de sécurité: 1.5 fois

Caractéristiques

- Fonction: soupape de régulation et de retenue
- Application: air, eau, huiles et gaz liquéfiés (tenir compte de la résistance de l'étanchéité)
- Matériau: laiton CW617N (CuZn40Pb2)
- Particularités: dimensions compactes, grande fiabilité

*** Options**

- No. 5 - Plaques indicatrices: au choix disponible en couleurs bleu, rouge, vert, voir VSD SO NV
- No. 6 - Couple pour bouchon de soupape dans tableau de commande = 3.4 Nm
- No. 7 - Joint: EPDM, FKM
- Autres versions: avec adaptateur femelle SO 00030 ou mâle SO 00040

Specifications

Working pressure (PN): 50 bar
 Temperature: -20°C to +80°C
 Safety factor: 1.5 times

Characteristics

- Function: regulating and stop valve
- Uses: air, water, oils and liquid gases (check resistance of seal)
- Material: brass CW617N (CuZn40Pb2)
- Special: compact dimensions, high reliability

*** Options**

- No. 5 - Valve labels: also available in colors blue, red, green, see VSD SO NV
- No. 6 - Torque for valve cap in panel mounting = 3.4 Nm
- No. 7 - Seal: EPDM, FKM
- Other versions: with female SO 00030 or male adaptor SO 00040

Durchflussdiagramm

Courbe de débit

Flow rate

Regulierventil / Robinets de réglage /
Regulating valve

Feinregulierventil / Robinets de réglage fin /
Fine regulating valve

SO NV 01A21

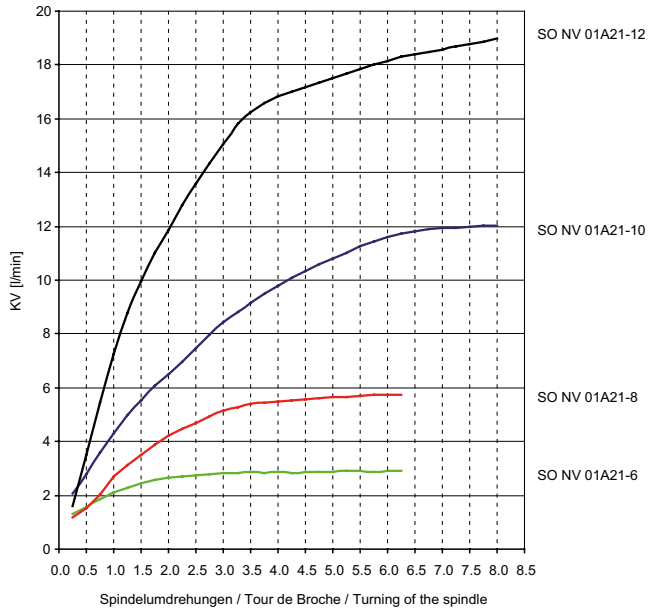

SO NV 01C21

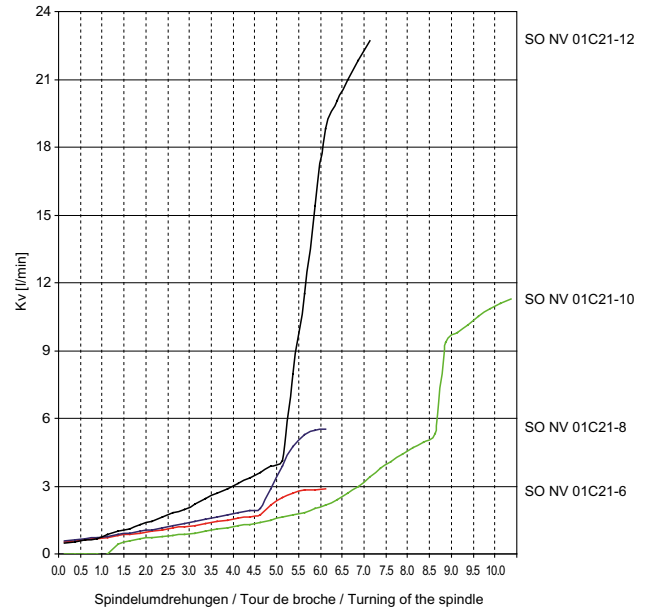

Sonderausführungen

siehe Kapitelübersicht

Exécutions en option

voir aperçu du chapitre

Optional services

see chapter overview

Zubehör

- Anschraubfuss für Wandmontage siehe SO 09900

Accessoires

- Support de fixation voir SO 09900

Accessoires

- Flange mount for wall fastening see SO 09900

Reguliertventil
Robinet de réglage
Regulating valve

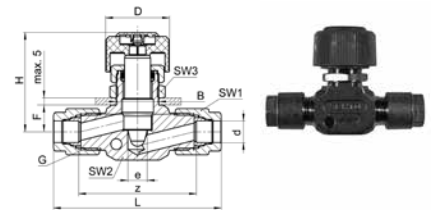
SO NV 01A21

Type -d	Mat.-Nr.	bar	G	SW1	SW2	SW3	L	D	H	B	F	z	e	kv	kg/100
SO NV 01A21-4	258.7100.040	50	1/8	12	14	19	64.0	26.0	47.0	16.5	10.0	50.5	3.5	5.5	12.200
SO NV 01A21-5	258.7100.050	50	1/8	12	14	19	66.0	26.0	47.0	16.5	10.0	50.5	4.0	5.5	12.200
SO NV 01A21-6	258.7100.060	50	1/8	12	14	19	66.0	26.0	47.0	16.5	10.0	50.5	4.0	5.5	12.000
SO NV 01A21-8	258.7100.080	50	1/4	14	14	19	70.5	26.0	47.0	16.5	10.0	51.0	5.0	6.2	15.000
SO NV 01A21-10	258.7100.100	50	3/8	17	18	24	84.0	36.0	54.5	20.5	14.0	60.0	6.5	15.0	26.000
SO NV 01A21-12	258.7100.120	50	1/2	19	22	27	95.0	36.0	66.0	24.5	15.0	66.5	9.5	20.0	33.500
SO NV 01A21-14	258.7100.140	50	1/2	22	22	27	99.0	36.0	66.0	24.5	15.0	67.0	9.5	20.0	34.600
SO NV 01A21-15	258.7100.150	50	1/2	22	22	27	99.0	36.0	66.0	24.5	15.0	67.0	9.5	20.0	34.800

d=Rohrassens-ø
 e=kleinste Bohrung
 kv=Kenngröße für das Durchflussverhalten (l/min)
 L=Mass in montiertem Zustand
 H=Ventil geöffnet

d=ø extérieur du tube
 e=ø-min. de passage
 kv=facteur d'écoulement (l/min)
 L=après montage
 H=robinet ouvert

d=tube outside diameter
 e=minimum bore
 kv=flow factor (l/min)
 L=installed length
 H=valve open

Regulierventil

mit Übergangsmuffe SO 00030

Robinet de réglage

avec adaptateur femelle SO 00030

Regulating valve

with female adaptor SO 00030

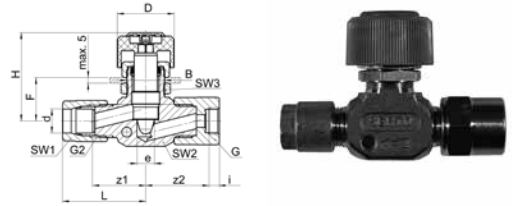

SO NV 01A30

Type -d-G	Mat.-Nr.	bar	G2	SW1	SW2	SW3	L	H	F	i	z1	z2	e	kv	kg/100	
G=Rohrgewinde (zylindrisch)			G=Filetage-gaz BSP (cylindrique)							G=BSP thread (parallel)						
SO NV 01A30-4-1/8	258.7130.060	50	1/8	12	14	19	32.0	47.0	21.0	8.0	25.0	30.5	4.0	4.5	13.194	
SO NV 01A30-5-1/8	258.7130.082	50	1/8	12	14	19	32.0	47.0	21.0	8.0	25.0	30.5	4.0	5.0	13.141	
SO NV 01A30-6-1/8	258.7130.100	50	1/8	12	14	19	32.0	47.0	21.0	8.0	25.0	30.5	4.0	5.5	12.878	
SO NV 01A30-6-1/4	258.7130.110	50	1/8	12	14	19	32.0	47.0	21.0	9.0	25.0	31.0	4.0	5.5	15.128	
SO NV 01A30-8-1/8	258.7130.160	50	1/4	14	14	19	35.0	47.0	21.0	8.0	25.0	31.0	5.0	6.5	15.450	
SO NV 01A30-8-1/4	258.7130.170	50	1/4	14	14	19	35.0	47.0	21.0	9.0	25.5	31.5	5.0	6.5	16.750	
SO NV 01A30-8-3/8	258.7130.180	50	1/4	14	14	19	35.0	47.0	21.0	9.5	25.0	32.5	5.0	6.5	18.350	
SO NV 01A30-8-1/2	258.7130.185	50	1/4	14	14	19	35.0	47.0	21.0	11.5	25.5	33.0	5.0	6.5	22.450	
SO NV 01A30-10-1/4	258.7130.270	50	3/8	17	18	24	42.0	54.5	23.5	9.0	30.0	36.0	6.5	15.0	27.750	
SO NV 01A30-10-3/8	258.7130.280	50	3/8	17	18	24	42.0	54.5	23.5	9.5	30.0	37.0	6.5	15.0	27.650	
SO NV 01A30-10-1/2	258.7130.285	50	3/8	17	18	24	42.0	54.5	23.5	11.5	30.0	37.5	6.5	15.0	35.000	
SO NV 01A30-12-1/4	258.7130.380	50	1/2	19	22	27	47.5	66.0	27.5	9.0	33.0	39.0	9.5	38.0	35.200	
SO NV 01A30-12-3/8	258.7130.390	50	1/2	19	22	27	47.5	66.0	27.5	9.5	33.0	40.0	9.5	38.0	36.350	
SO NV 01A30-12-1/2	258.7130.400	50	1/2	19	22	27	47.5	66.0	27.5	11.5	33.0	40.0	9.5	38.0	40.100	
SO NV 01A30-12-3/4	258.7130.405	50	1/2	19	22	27	47.5	66.0	27.5	14.0	33.0	41.5	9.5	38.0	41.250	
SO NV 01A30-14-1/2	258.7130.504	50	1/2	22	22	27	49.5	66.0	27.5	11.0	33.5	40.0	9.5	40.0	40.400	
SO NV 01A30-15-1/2	258.7130.534	50	1/2	22	22	27	49.5	66.0	27.5	11.0	33.5	40.0	9.5	40.0	40.400	

D = ø 26 mm ≤ Anschlussgröße 8
ø 36 mm ≥ Anschlussgröße 10

D = ø 26 mm ≤ Dimension 8
ø 36 mm ≥ Dimension 10

D = ø 26 mm ≤ Dimension 8
ø 36 mm ≥ Dimension 10

B = ø 16,5 mm ≤ Anschlussgröße 8
ø 20,5 mm ≥ Anschlussgröße 10
ø 24,5 mm ≥ Anschlussgröße 12

B = ø 16,5 mm ≤ Dimension 8
ø 20,5 mm ≥ Dimension 10
ø 24,5 mm ≥ Dimension 12

B = ø 16,5 mm ≤ Dimension 8
ø 20,5 mm ≥ Dimension 10
ø 24,5 mm ≥ Dimension 12

d=Rohrassen-ø
e=kleinste Bohrung
kv=Kenngröße für das Durchflussverhalten (l/min)
L=Mass in montiertem Zustand
H=Ventil geöffnet

d=ø extérieur du tube
e=ø-min. de passage
kv=facteur d'écoulement (l/min)
L=après montage
H=robinet ouvert

d=tube outside diameter
e=minimum bore
kv=flow factor (l/min)
L=installed length
H=valve open

Regulierventil

mit Übergangsnippel SO 00040

Robinet de réglage

avec adaptateur mâle SO 00040

Regulating valve

with male adaptor SO 00040

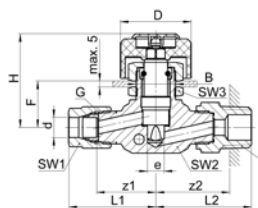
SO NV 01A40

Type -d -R	Mat.-Nr.	bar	G	SW1	SW2	SW3	L1	L2	H	F	z1	z2	e	kv	kg/100	
R=Rohrgewinde (kegelig)				R=Filetage-gaz BSP (conique)							R=BSP thread (tapered)					
SO NV 01A40-4-1/8	258.7140.060	50	1/8	12	14	19	32.0	34.5	47.0	21.0	25.0	28.0	3.5	4.5	12.544	
SO NV 01A40-5-1/8	258.7140.082	50	1/8	12	14	19	32.0	34.5	47.0	21.0	25.0	28.0	4.0	5.0	12.491	
SO NV 01A40-6-1/8	258.7140.100	50	1/8	12	14	19	32.0	34.5	47.0	21.0	25.0	28.0	4.0	5.5	12.228	
SO NV 01A40-6-1/4	258.7140.110	50	1/8	12	14	19	32.0	38.5	47.0	21.0	25.0	31.0	4.0	5.5	12.000	
SO NV 01A40-8-1/8	258.7140.160	50	1/4	14	14	19	35.0	36.5	47.0	21.0	25.5	30.5	5.0	6.5	14.900	
SO NV 01A40-8-1/4	258.7140.170	50	1/4	14	14	19	35.0	40.5	47.0	21.0	25.5	31.0	5.0	6.5	15.500	
SO NV 01A40-8-3/8	258.7140.180	50	1/4	14	14	19	35.0	40.5	47.0	21.0	25.5	30.5	5.0	6.5	15.750	
SO NV 01A40-8-1/2	258.7140.185	50	1/4	14	14	19	35.0	44.5	47.0	21.0	25.5	31.5	5.0	6.5	18.600	
SO NV 01A40-10-1/4	258.7140.270	50	3/8	17	18	24	42.0	46.5	54.5	23.5	30.0	37.0	6.5	15.0	26.650	
SO NV 01A40-10-3/8	258.7140.280	50	3/8	17	18	24	42.0	46.5	54.5	23.5	30.0	36.5	6.5	15.0	27.150	
SO NV 01A40-10-1/2	258.7140.285	50	3/8	17	18	24	42.0	48.5	54.5	23.5	30.0	36.5	6.5	15.0	27.900	
SO NV 01A40-12-1/4	258.7140.380	50	1/2	19	22	27	47.5	49.5	66.0	27.5	33.0	40.0	9.5	38.0	24.400	
SO NV 01A40-12-3/8	258.7140.390	50	1/2	19	22	27	47.5	49.5	66.0	27.5	33.0	39.5	9.5	38.0	34.800	
SO NV 01A40-12-1/2	258.7140.400	50	1/2	19	22	27	47.5	51.5	66.0	27.5	33.0	38.5	9.5	38.0	35.650	
SO NV 01A40-12-3/4	258.7140.405	50	1/2	19	22	27	47.5	49.5	66.0	27.5	33.0	38.5	9.5	38.0	38.650	
SO NV 01A40-14-1/2	258.7140.504	50	1/2	22	22	27	49.5	51.5	66.0	27.5	33.5	38.5	9.5	40.0	35.750	
SO NV 01A40-15-1/2	258.7140.534	50	1/2	22	22	27	49.5	51.5	66.0	27.5	33.5	38.5	9.5	40.0	35.950	

D = ø 26 mm ≤ Anschlussgröße 8
ø 36 mm ≥ Anschlussgröße 10

D = ø 26 mm ≤ Dimension 8
ø 36 mm ≥ Dimension 10

D = ø 26 mm ≤ Dimension 8
ø 36 mm ≥ Dimension 10

B = ø 16,5 mm ≤ Anschlussgröße 8
ø 20,5 mm ≥ Anschlussgröße 10
ø 24,5 mm ≥ Anschlussgröße 12

B = ø 16,5 mm ≤ Dimension 8
ø 20,5 mm ≥ Dimension 10
ø 24,5 mm ≥ Dimension 12

B = ø 16,5 mm ≤ Dimension 8
ø 20,5 mm ≥ Dimension 10
ø 24,5 mm ≥ Dimension 12

d=Rohrassen-ø
e=kleinste Bohrung
kv=Kenngröße für das Durchflussverhalten (l/min)
L=Mass in montiertem Zustand
H=Ventil geöffnet

d=ø extérieur du tube
e=ø-min. de passage
kv=facteur d'écoulement (l/min)
L=après montage
H=robinet ouvert

d=tube outside diameter
e=minimum bore
kv=flow factor (l/min)
L=installed length
H=valve open

Feinreguliertventil
Robinet de réglage fin
Fine regulating valve

12

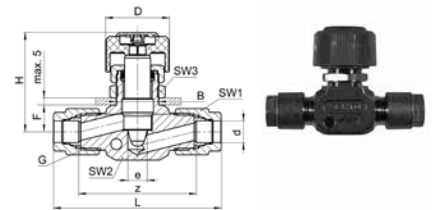

SO NV 01C21

Type -d	Mat.-Nr.	bar	G	SW1	SW2	SW3	L	D	H	B	F	z	e	kv	kg/100
SO NV 01C21-4	258.7200.040	50	1/8	12	14	19	64.0	26.0	47.0	16.5	10.0	50.5	3.5	4.5	12.000
SO NV 01C21-5	258.7200.050	50	1/8	12	14	19	66.0	26.0	47.0	16.5	10.0	50.5	4.0	5.0	12.000
SO NV 01C21-6	258.7200.060	50	1/8	12	14	19	66.0	26.0	47.0	16.5	10.0	50.5	4.0	5.5	11.800
SO NV 01C21-8	258.7200.080	50	1/4	14	14	19	70.0	26.0	47.0	16.5	10.0	51.0	5.0	6.5	14.500
SO NV 01C21-10	258.7200.100	50	3/8	17	18	24	84.0	36.0	54.5	20.5	14.0	60.0	6.5	15.0	25.800
SO NV 01C21-12	258.7200.120	50	1/2	19	22	27	95.0	36.0	66.0	24.5	15.0	66.5	9.5	38.0	33.000
SO NV 01C21-14	258.7200.140	50	1/2	22	22	27	99.0	36.0	66.0	24.5	15.0	67.0	9.5	40.0	34.400
SO NV 01C21-15	258.7200.150	50	1/2	22	22	27	99.0	36.0	66.0	24.5	15.0	67.0	9.5	40.0	34.600

d=Rohrassens-ø
 e=kleinste Bohrung
 kv=Kenngröße für das Durchflussverhalten (l/min)
 L=Mass in montiertem Zustand
 H=Ventil geöffnet

d=ø extérieur du tube
 e=ø-min. de passage
 kv=facteur d'écoulement (l/min)
 L=après montage
 H=robinet ouvert

d=tube outside diameter
 e=minimum bore
 kv=flow factor (l/min)
 L=installed length
 H=valve open

Regulier- / Feinregulier- / Dosiereckventil
Robinet-équerre de réglage / réglage fin / précision
Elbow regulating / fine regulating / metering valve

**SO NV 01A21E/
 EL/ES/ET**
SO NV 01C21E/EL
SO NV 01D21E/ET

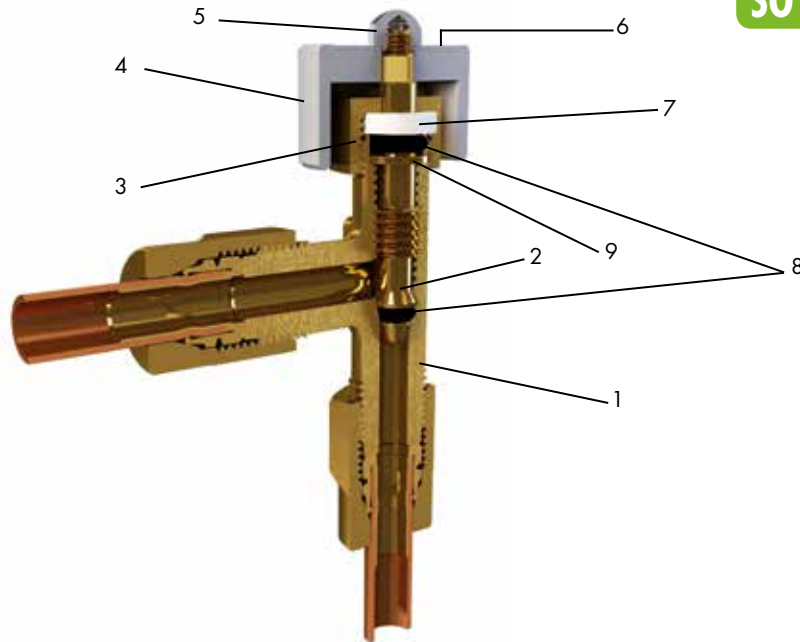

Nr. No. No.	Bezeichnung Désignation Description	Material Matériau Material	Nr. No. No.	Bezeichnung Désignation Description	Material Matériau Material	Nr. No. No.	Bezeichnung Désignation Description	Material Matériau Material
1	Ventilkörper Corps de soupape Valve body	Messing Laiton Brass	4	Handrad (grau) Manche (gris) Handwheel (grey)	Aluminium	7	Dichtungs-Set Set des joints Set of seals	PA
2	Ventilspindel Tige de soupape Valve spindle	Messing Laiton Brass	5	Hutmutter Écrou borgne Cap nut	Mess. CV Laiton CV Brass CV	8*	Dichtung Joint Seal	NBR
3	Ventilkappe Bouchon de soupape Valve cap	Messing Laiton Brass	6*	Ventilschild (schwarz) Plaque indicatrice (noir) Valve label (black)	Aluminium	9	Unterlagsscheibe Rondelle Washer	Messing Laiton Brass

Spezifikationen

Betriebsdruck (PN): 50 bar
 Temperatur: -20°C bis +80°C
 Sicherheitsfaktor: 1.5-fach

Merkmale

- Funktion:
Regulier- und Absperrventil (SO NV 01Axx)
Feinregulierventil (SO NV 01Cxx)
Dosierventil (SO NV 01Dxx)
- Einsatz: Luft, Wasser, Öle und Flüssiggase
(Beständigkeit Dichtung beachten)
- Material: Messing CW617N (CuZn40Pb2)

*** Optionen**

- Nr. 6 - Ventilschild: wahlweise auch in den Farben blau, rot, grün, gelb, siehe VSD SO NV
- Nr. 8 - Dichtung: EPDM, FPM
- Varianten: mit Übergangsmuffe SO 00030 oder Übergangsnippel SO 00040

Spécifications

Pression de service (PN): 50 bar
 Température: -20°C à +80°C
 Facteur de sécurité: 1.5 fois

Caractéristiques

- Fonction:
Soupape de régulation et de retenue (SO NV 01Axx)
Soupape de réglage fin (SO NV 01Cxx)
Soupape de dosage (SO NV 01Dxx)
- Application: air, eau, huiles et gaz liquéfiés
(tenir compte de la résistance de l'étanchéité)
- Matériau: laiton CW617N (CuZn40Pb2)

*** Options**

- No. 6 - Plaques indicatrices: au choix disponible en couleurs bleu, rouge, vert, jaune, voir VSD SO NV
- No. 8 - Joint: EPDM, FPM
- Autres versions: avec adaptateur femelle SO 00030 ou mâle SO 00040

Specifications

Working pressure (PN): 50 bar
 Temperature: -20°C to +80°C
 Safety factor: 1.5 times

Characteristics

- Function:
Regulating and stop valve (SO NV 01Axx)
Fine regulating valve (SO NV 01Cxx)
Dosing valve (SO NV 01Dxx)
- Uses: air, water, oils and liquid gases (check resistance of seal)
- Material: brass CW617N (CuZn40Pb2)

*** Options**

- No. 6 - Valve labels: also available in colors blue, red, green, yellow, see VSD SO NV
- No. 8 - Seal: EPDM, FPM
- Other versions: with female SO 00030 or male adaptor SO 00040

Durchflussdiagramm

Courbe de débit

Flow rate

SO NV 01A21E / SO NV 01A21EL / SO NV 01A21ES / SO NV 01A21ET /
SO NV 01C21E / SO NV 01C21EL / SO NV 01D21E / SO NV 01D21ET

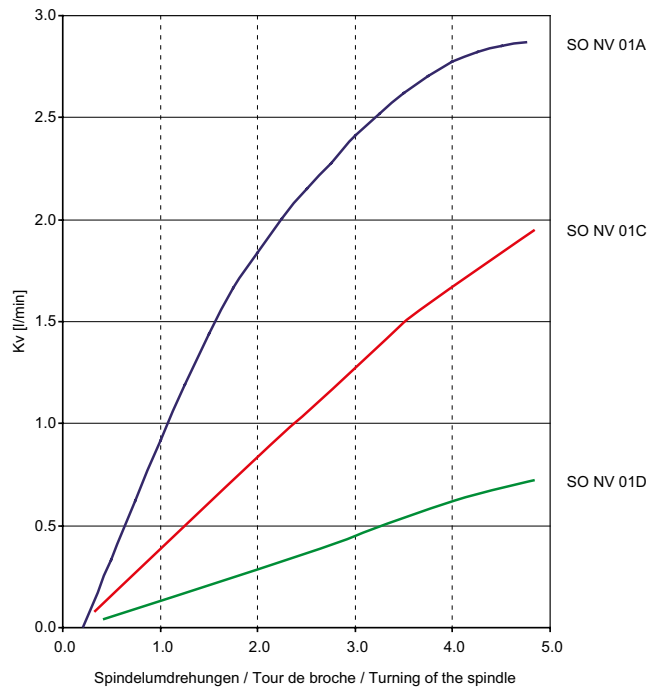

Sonderausführungen

siehe Kapitelübersicht

Exécutions en option

voir aperçu du chapitre

Optional services

see chapter overview

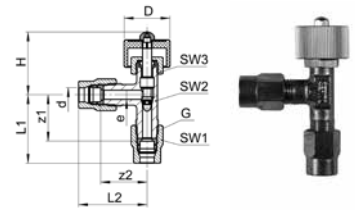
Regulier-Eckventil
Robinet-équerre de réglage
Elbow regulating valve

SO NV 01A21E

Type -d	Mat.-Nr.	bar	G	SW1	SW2	SW3	L1	L2	D	H	z1	z2	e	kv	kg/100
SO NV 01A21E-4	258.7420.040	50	1/8	12	10	12	27.0	27.0	20.0	32.0	20.0	20.0	3.5	3.5	6.000
SO NV 01A21E-5	258.7420.050	50	1/8	12	10	12	27.0	27.0	20.0	32.0	20.0	20.0	4.0	4.5	6.000
SO NV 01A21E-6	258.7420.060	50	1/8	12	10	12	28.0	27.0	20.0	32.0	20.0	20.0	4.0	5.0	6.000

Regulier-Eckventil

mit Übergangsmuffe SO 00030

Robinet-équerre de réglage

avec adaptateur femelle SO 00030

Elbow regulating valve

with female adaptor SO 00030

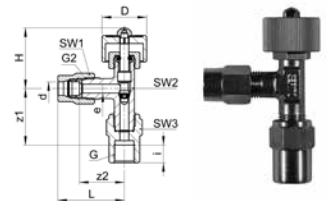
SO NV 01A30E

Type -d-G	Mat.-Nr.	bar	G2	SW1	SW2	SW3	L	D	H	i	z1	z2	e	kv	kg/100
G=Rohrgewinde (zylindrisch)			G=Filetage-gaz BSP (cylindrique)												
			G=BSP thread (parallel)												
SO NV 01A30E-4-1/8	258.7430.060	50	1/8	12	10	14	26.0	20.0	25.0	8.0	24.5	18.0	3.5	3.5	6.994
SO NV 01A30E-5-1/8	258.7430.082	50	1/8	12	10	14	26.0	20.0	25.0	8.0	24.5	18.0	4.0	4.5	6.941
SO NV 01A30E-6-1/8	258.7430.100	50	1/8	12	10	14	27.0	20.0	25.0	8.0	24.5	18.0	4.0	5.0	6.878

Regulier-Eckventil

mit Übergangsnippel SO 00040

Robinet-équerre de réglage

avec adaptateur mâle SO 00040

Elbow regulating valve

with male adaptor SO 00040

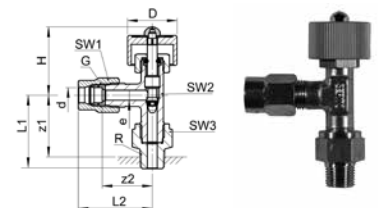
SO NV 01A40E

Type -d-R	Mat.-Nr.	bar	G	SW1	SW2	SW3	L1	L2	D	H	z1	z2	e	kv	kg/100
R=Rohrgewinde (kegelig)			R=Filetage-gaz BSP (conique)												
			R=BSP thread (tapered)												
SO NV 01A40E-4-1/8	258.7440.060	50	1/8	12	10	14	27.5	25.0	20.0	24.0	25.5	18.0	3.5	3.5	6.344
SO NV 01A40E-5-1/8	258.7440.082	50	1/8	12	10	14	27.5	25.0	20.0	24.5	25.5	18.0	4.0	4.5	6.291
SO NV 01A40E-6-1/8	258.7440.100	50	1/8	12	10	14	29.5	29.5	20.0	26.0	25.5	20.0	4.0	5.0	6.228

d=Rohrassens-ø
 e=kleinste Bohrung
 kv=Kenngröße für das Durchflussverhalten (l/min)
 L=Mass in montiertem Zustand
 H=Ventil geöffnet

d=ø extérieur du tube
 e=ø-min. de passage
 kv=facteur d'écoulement (l/min)
 L=après montage
 H=robinet ouvert

d=tube outside diameter
 e=minimum bore
 kv=flow factor (l/min)
 L=installed length
 H=valve open

Regulier-Eckventil

mit Einstellzapfen

Robinet-équerre de réglage

orientable

Elbow regulating valve

adjustable

SO NV 01A21EL

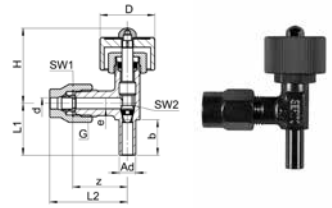

Type -d -Ad	Mat.-Nr.	bar	G	SW1	SW2	L1	L2	D	H	b	z	e	kv	kg/100
SO NV 01A21EL-4-A6	YDD.060.0021	50	1/8	12	10	19.0	27.0	20.0	32.0	13.0	20.0	3.5	3.5	5.000
SO NV 01A21EL-5-A6	YDD.060.0022	50	1/8	12	10	19.0	27.0	20.0	32.0	13.0	20.0	3.5	4.5	5.000
SO NV 01A21EL-6-A6	YDD.060.0023	50	1/8	12	10	19.0	28.0	20.0	32.0	13.0	20.0	3.5	4.5	5.000

Regulier-Eckventil

mit Schottadapter

Robinet-équerre de réglage

avec adaptateur pour passage de cloison

Elbow regulating valve

with bulkhead adapter

SO NV 01A21ES

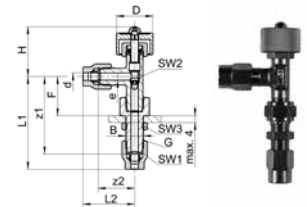

Type -d	Mat.-Nr.	bar	G	SW1	SW2	SW3	L1	L2	H	F	z1	z2	e	kv	kg/100
SO NV 01A21ES-4	YDD.060.0032	50	1/8	12	10	12	50.5	27.0	32.0	21.5	42.5	20.0	3.5	3.5	8.000
SO NV 01A21ES-5	YDD.060.0033	50	1/8	12	10	12	51.5	27.0	32.0	21.5	42.5	20.0	4.0	4.5	8.000
SO NV 01A21ES-6	YDD.060.0034	50	1/8	12	10	12	51.5	28.0	32.0	21.5	42.5	20.0	4.0	4.5	8.000

D = ø 20 mm
B = ø 10 mm

D = ø 20 mm
B = ø 10 mm

D = ø 20 mm
B = ø 10 mm

Regulier-Eckventil

Schalttafelaustrführung

Robinet-équerre de réglage

pour tableau de commande

Elbow regulating valve

for panel mounting

SO NV 01A21ET

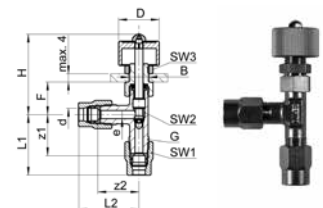

Type -d	Mat.-Nr.	bar	G	SW1	SW2	SW3	L1	L2	H	F	z1	z2	e	kv	kg/100
SO NV 01A21ET-4	YDD.060.0100	50	1/8	12	10	12	27.0	27.0	44.0	18.0	20.0	20.0	3.5	3.5	7.000
SO NV 01A21ET-5	YDD.060.0101	50	1/8	12	10	12	28.0	27.0	45.0	18.0	20.0	20.0	4.0	4.5	7.000
SO NV 01A21ET-6	YDD.060.0102	50	1/8	12	10	12	28.0	28.0	46.0	16.0	20.0	20.0	4.0	4.5	7.000

D = ø 20 mm
B = ø 10 mm

D = ø 20 mm
B = ø 10 mm

D = ø 20 mm
B = ø 10 mm

d=Rohrassen-ø
e=kleinste Bohrung
kv=Kenngröße für das Durchflussverhalten (l/min)
L=Mass in montiertem Zustand
H=Ventil geöffnet

d=ø extérieur du tube
e=ø-min. de passage
kv=facteur d'écoulement (l/min)
L=après montage
H=robinet ouvert

d=tube outside diameter
e=minimum bore
kv=flow factor (l/min)
L=installed length
H=valve open

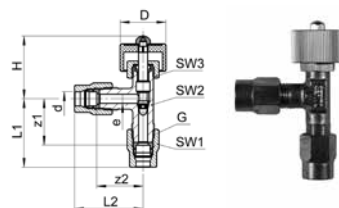
Feinregulier-Eckventil
Robinet-équerre de réglage fin
Elbow fine regulating valve

SO NV 01C21E

Type -d	Mat.-Nr.	bar	G	SW1	SW2	SW3	L1	L2	D	H	z1	z2	e	kv	kg/100
SO NV 01C21E-4-4	YDD.060.0200	50	1/8	12	10	12	27.0	27.0	20.0	32.0	20.0	20.0	2.5	3.0	6.000
SO NV 01C21E-5	YDD.060.0201	50	1/8	12	10	12	27.0	28.0	20.0	32.0	20.0	20.0	2.5	3.0	6.000
SO NV 01C21E-6	YDD.060.0202	50	1/8	12	10	12	28.0	28.0	20.0	32.0	20.0	20.0	2.5	3.0	6.000
SO NV 01C21E-6,35	YDD.060.0203	50	1/8	12	10	12	28.0	28.0	20.0	32.0	20.0	20.0	2.5	3.0	6.000

Feinregulier-Eckventil

mit Einstellzapfen

Robinet-équerre de réglage fin

orientable

Elbow fine regulating valve

adjustable

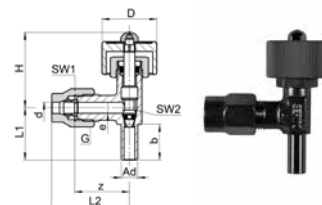
SO NV 01C21EL

Type -d -A	Mat.-Nr.	bar	G	SW1	SW2	L1	L2	D	H	b	z	e	kv	kg/100
SO NV 01C21EL-4-A6	YDD.060.0212	50	1/8	12	10	19.0	27.0	20.0	32.0	13.0	20.0	2.5	3.0	5.000
SO NV 01C21EL-5-A6	YDD.060.0213	50	1/8	12	10	19.0	27.0	20.0	32.0	13.0	20.0	2.5	3.0	5.000
SO NV 01C21EL-6-A6	YDD.060.0214	50	1/8	12	10	19.0	28.0	20.0	32.0	13.0	20.0	2.5	5.0	5.000

d=Rohrassens-ø

e=kleinste Bohrung

kv=Kenngröße für das Durchflussverhalten (l/min)

L=Mass in montiertem Zustand

H=Ventil geöffnet

d=ø extérieur du tube

e=ø-min. de passage

kv=facteur d'écoulement (l/min)

L=après montage

H=robinet ouvert

d=tube outside diameter

e=minimum bore

kv=flow factor (l/min)

L=installed length

H=valve open

Dosier-Eckventil

mit Feinregulierspindel 1:50

Robinet-équerre de réglage de
précision

à aiguille 1:50

Metering elbow valve

with fine-regulating spindle 1:50

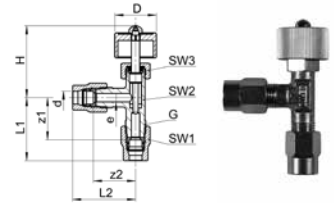
SO NV 01D21E

Type-d	Mat.-Nr.	bar	G	SW1	SW2	SW3	L1	L2	D	H	z1	z2	e	kv	kg/100
SO NV 01D21E-4	YDD.060.0250	50	1/8	12	10	12	27.0	27.0	20.0	32.0	20.0	20.0	2.5	0.1	6.000
SO NV 01D21E-5	YDD.060.0251	50	1/8	12	10	12	27.0	27.0	20.0	32.0	20.0	20.0	2.5	0.1	6.000
SO NV 01D21E-6	YDD.060.0252	50	1/8	12	10	12	28.0	28.0	20.0	32.0	20.0	20.0	2.5	0.1	6.000
SO NV 01D21E-6,35	YDD.060.0253	50	1/8	12	10	12	28.0	28.0	20.0	32.0	20.0	20.0	2.5	0.1	6.000

Dosier-Eckventil

mit Feinregulierspindel 1:50, Schottausführung

Robinet-équerre de réglage de
précision

à aiguille 1:50, à revêtement

Metering elbow valve

with fine-regulating spindle 1:50, bulkhead version

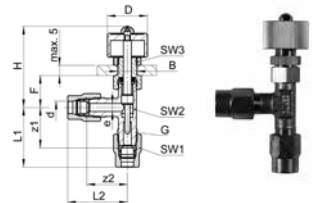
SO NV 01D21ET

Type-d	Mat.-Nr.	bar	G	SW1	SW2	SW3	L1	L2	H	F	z1	z2	e	kv	kg/100
SO NV 01D21ET-4	YDD.060.0350	50	1/8	12	10	12	27.0	27.0	40.0	18.5	20.0	20.0	2.5	0.1	7.000
SO NV 01D21ET-5	YDD.060.0351	50	1/8	12	10	12	27.0	27.0	40.0	18.5	20.0	20.0	2.5	0.1	7.000
SO NV 01D21ET-6	YDD.060.0352	50	1/8	12	10	12	28.0	28.0	40.0	16.0	20.0	20.0	2.5	0.1	7.000
SO NV 01D21ET-6,35	YDD.060.0353	50	1/8	12	10	12	28.0	28.0	40.0	18.5	20.0	20.0	2.5	0.1	7.000

 D = ø 20 mm
 B = ø 10 mm

 D = ø 20 mm
 B = ø 10 mm

 D = ø 20 mm
 B = ø 10 mm

d=Rohraussen-ø
 e=kleinste Bohrung
 kv=Kenngröße für das Durchflussverhalten (l/min)
 L=Mass in montiertem Zustand
 H=Ventil geöffnet

d=ø extérieur du tube
 e=ø-min. de passage
 kv=facteur d'écoulement (l/min)
 L=après montage
 H=robinet ouvert

d=tube outside diameter
 e=minimum bore
 kv=flow factor (l/min)
 L=installed length
 H=valve open

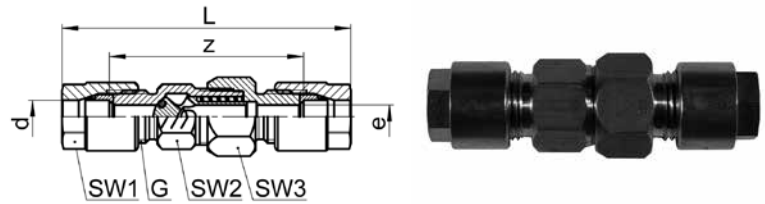
Kegelrückschlagventil
Soupape de retenue à siège conique
Taper seat non-return valve
SO CV 03A21

Type-d	Mat.-Nr.	bar	G	SW1	SW2	SW3	L	z	e	kg/100
SO CV 03A21-4	258.3000.040	100	1/8	12	12	14	56.0	42.5	3.4	4.700
SO CV 03A21-5	258.3000.050	100	1/8	12	12	14	56.0	42.5	3.8	4.600
SO CV 03A21-6	258.3000.060	100	1/8	12	12	14	59.0	43.0	3.8	4.800
SO CV 03A21-8	258.3000.080	64	1/4	14	14	17	67.5	48.5	5.8	8.800
SO CV 03A21-10	258.3000.100	64	1/2	19	24	27	88.5	65.0	10.5	26.400
SO CV 03A21-12	258.3000.120	50	1/2	19	24	27	92.0	65.5	10.5	27.000
SO CV 03A21-14	258.3000.140	50	1/2	22	24	27	97.5	66.0	10.5	32.000
SO CV 03A21-15	258.3000.150	50	1/2	22	24	27	97.5	66.0	10.5	29.000

Temperatur -20°C/+80°C

Die strömungsgünstige Formgebung des Ventilkegels mit dem Ringkanal, die schrägen Bohrungen und die Anordnungen der Feder ausserhalb der Durchflusszone bewirken einen geringen Druckverlust. Durch den besonderen Einbau im Gehäuse wirkt der zylindrische Teil des Ventilkegels wie ein Stossdämpfer, so dass Flattern vermieden und Druckschläge gedämpft werden.

Geeignet für Luft, Öle, Wasser, Benzin und Flüssiggase.

Technische Hinweise:

Ventil und Anschlüsse sind aus Messing, Feder aus rostfreiem Stahl 1.4401.
O-Ring aus NBR.
Öffnungsdruck Normalausführung 0,2 bar.
Andere Drücke: 0,5; 1; 2; 3 bar,
andere Dichtungsmaterialien und andere Federmaterialien möglich.

Température -20°C/+80°C

La forme du cône, favorable à l'écoulement, le canal circulaire, les perçages obliques et la disposition du ressort en dehors de la veine d'écoulement limitent la perte de charge à un minimum. Grâce à sa disposition particulière dans le corps desoupape, la queue cylindrique du pointeau fait office d'amortisseur et atténue ainsi les vibrations et les coups de bélier.

Utilisable pour: air, huiles, eau, essence et gaz liquéfiés.

Données techniques:

Soupape, pointeau et écrous en laiton: ressort en acier inoxydable 1.4401.
Joint torique en matière NBR.
Pression d'ouverture en version standard 0,2 bar.
Autre pressions: 0,5; 1; 2; 3 bar, autre matériaux de joint et autre matériaux de ressort sont possible.

Temperature -20°C/+80°C

The true-to-flow design of the valve with the annular channel, slanting ports and the arrangement of the spring outside the flow zone make for a low pressure loss. By way of its special fit in the body, the cylindrical part of the valve plunger acts as damper, so that hammering is avoided and pressure shocks damped.

Suitable for air, oils, water, petrol and liquid gases.

Technical notes:

Valve body, valve components and connections of brass. Spring of stainless steel 1.4401.
O-ring of NBR.
Opening pressure 0,2 bar for standard model.
Other pressures: 0,5; 1; 2; 3 bar, other sealing materials and other spring materials are possible.

Kegelrückschlagventil

mit Übergangsmuffe SO 00030

Soupape de retenue à siège conique

avec adaptateur femelle SO 00030

Taper seat non-return valve

with female adaptor SO 00030

SO CV 03A30

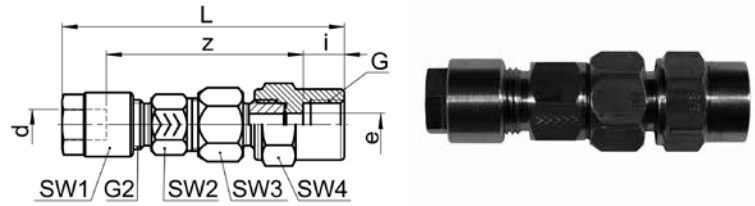

Type -d -G	Mat.-Nr.	bar	G2	SW1	SW2	SW3	SW4	L	i	z	e	kg/100
G=Rohrgewinde (zylindrisch)	G=Filetage-gaz BSP (cylindrique)			G=BSP thread (parallel)								
SO CV 03A30-6-1/8	258.3300.100	100	1/8	12	12	14	14	63.0	10.0	46.0	3.4	4.100
SO CV 03A30-6-1/4	258.3300.110	100	1/8	12	12	14	19	64.5	11.0	46.5	3.8	7.300
SO CV 03A30-8-1/8	258.3300.160	100	1/4	14	14	17	19	71.5	10.0	52.0	5.8	7.500
SO CV 03A30-8-1/4	258.3300.170	100	1/4	14	14	17	19	73.0	11.0	52.5	5.8	7.700
SO CV 03A30-8-3/8	258.3300.180	100	1/4	14	14	17	22	74.5	12.0	53.0	5.8	7.900
SO CV 03A30-8-1/2	258.3300.185	100	1/4	14	14	17	27	77.0	14.0	53.5	5.8	8.300
SO CV 03A30-10-1/4	258.3300.270	64	1/2	19	24	27	27	95.5	11.0	70.5	8.5	22.600
SO CV 03A30-10-3/8	258.3300.280	64	1/2	19	24	27	27	96.5	12.0	70.5	10.0	22.700
SO CV 03A30-10-1/2	258.3300.285	64	1/2	19	24	27	30	99.0	14.0	71.0	10.5	23.100
SO CV 03A30-12-1/4	258.3300.380	50	1/2	19	24	27	27	95.0	11.0	69.5	8.5	22.600
SO CV 03A30-12-3/8	258.3300.390	50	1/2	19	24	27	27	96.0	12.0	69.5	10.0	22.700
SO CV 03A30-12-1/2	258.3300.400	50	1/2	19	24	27	30	98.5	14.0	70.0	10.5	23.100
SO CV 03A30-12-3/4	258.3300.405	50	1/2	19	24	27	32	102.0	17.0	70.5	10.5	23.300
SO CV 03A30-14-1/2	258.3300.504	50	1/2	22	24	27	30	101.5	14.0	70.0	10.5	24.100
SO CV 03A30-15-1/2	258.3300.534	50	1/2	22	24	27	30	101.5	14.0	70.0	10.5	24.100

Kegelrückschlagventil

mit Übergangsnippel SO 00040

Soupape de retenue à siège conique

avec adaptateur mâle SO 00040

Taper seat non-return valve

with male adaptor SO 00040

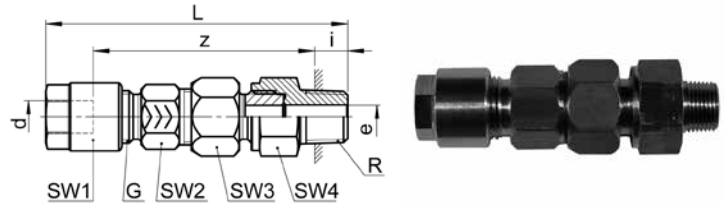

SO CV 03A40

Type -d-R	Mat.-Nr.	bar	G	SW1	SW2	SW3	SW4	L	i	z	e	kg/100
R=Rohrgewinde (kegelig)				R=Filetage-gaz BSP (conique)				R=BSP thread (tapered)				
SO CV 03A40-6-1/8	258.3400.100	100	1/8	12	12	14	14	61.0	5.0	47.0	3.4	5.000
SO CV 03A40-6-1/4	258.3400.110	100	1/8	12	12	14	14	65.0	8.0	48.0	3.4	5.800
SO CV 03A40-8-1/8	258.3400.160	100	1/4	14	14	17	17	70.0	5.0	54.5	4.5	9.900
SO CV 03A40-8-1/4	258.3400.170	100	1/4	14	14	17	17	74.0	8.0	55.5	5.8	10.500
SO CV 03A40-8-3/8	258.3400.180	100	1/4	14	14	17	17	74.0	8.0	55.5	5.8	10.700
SO CV 03A40-8-1/2	258.3400.185	100	1/4	14	14	17	22	78.0	10.0	57.5	5.8	13.600
SO CV 03A40-10-1/4	258.3400.270	64	1/2	19	24	27	27	96.5	8.0	74.5	7.0	27.600
SO CV 03A40-10-3/8	258.3400.280	64	1/2	19	24	27	27	96.5	8.0	74.5	10.0	28.000
SO CV 03A40-10-1/2	258.3400.285	64	1/2	19	24	27	27	98.0	10.0	74.5	10.5	28.850
SO CV 03A40-12-1/4	258.3400.380	50	1/2	19	24	27	27	96.0	8.0	73.5	7.0	27.600
SO CV 03A40-12-3/8	258.3400.390	50	1/2	19	24	27	27	96.0	8.0	73.5	10.0	28.000
SO CV 03A40-12-1/2	258.3400.400	50	1/2	19	24	27	27	98.0	10.0	73.5	10.5	28.850
SO CV 03A40-12-3/4	258.3400.405	50	1/2	19	24	27	30	100.0	12.0	73.5	10.5	31.850
SO CV 03A40-14-1/2	258.3400.504	50	1/2	22	24	27	27	101.5	10.0	74.0	10.5	29.850
SO CV 03A40-15-1/2	258.3400.534	50	1/2	22	24	27	27	101.5	10.0	74.0	10.5	29.850

Kugelhahn voller Durchgang

Dichtung von innen gesichert

Robinet à bille avec passage total

joint intérieur fixé

Ball valve with full flow

seal locked from the inside

SO BV 08C00

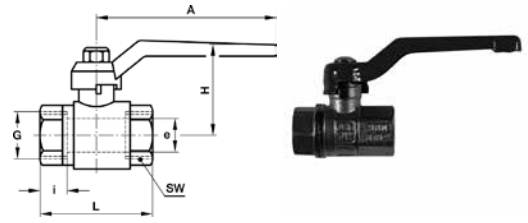

Type -G	Mat.-Nr.	bar	SW	L	A	H	i	e	kg/100
G=Rohrgewinde (zylindrisch)	G=Filetage-gaz BSP (cylindrique)	G=BSP thread (parallel)							
SO BV 08C00-1/4	YBD.7800.001	40	19	46.0	85.0	42.0	10.0	9.0	12.000
SO BV 08C00-3/8	YBD.7800.002	40	22	48.0	82.5	43.0	12.0	11.0	15.400
SO BV 08C00-1/2	YBD.7800.003	40	26	58.0	85.0	44.0	12.0	11.0	22.000
SO BV 08C00-3/4	YBD.7800.004	40	32	70.0	85.0	48.0	15.0	20.0	34.400
SO BV 08C00-1	YBD.7800.005	40	39	83.0	95.0	59.0	18.0	25.0	54.400

Kugelhahn mit vollem Durchgang, Dichtung von innen gesichert.

Geeignet für: Wasser, Öle, Brennstoffe, Druckluft, saturierter Dampf, nicht korrosive Chemikalien, u.a.

Technische Hinweise:

Temperaturbereich: -30°C bis +180°C

Werkstoffe:

Körper und Mutter: MS 58 vernickelt

Kugelsitz und Dichtung: PTFE

Kugel: Messing CuZn39Pb3 hartverchromt

Griff: Alu-Kunststoffbeschichtung

Sicherungsmutter: Stahl verzinkt

Dienstleistungsoptionen auf Anfrage

Robinet à bille avec passage total, joint intérieur fixé.

Utilisable pour: eau, huile, mazout, combustible, air comprimé, vapeur saturée, agents chimiques non-corrosifs et autres.

Données techniques:

Plage de température admissible: -30°C à +180°C

Matériau:

Corps et écrou: Laiton 58 nickelé

Logement de bille et joint: PTFE

Bille: Laiton CuZn39Pb3, chromage dur

Manette: Aluminium plastifié

Écrou de sécurité: Acier zingué

Options de service sur demande

Ball valve with full flow, seal locked from the inside.

Suitable for: water, oils, fuel, compressed air, saturated steam, non-corrosive chemicals and others.

Technical notes:

Temperature range: -30°C to +180°C

Material:

Body and nut: nickel-plated brass 58

Ball fit and washer: PTFE

Ball: hard chromium-plated brass

CuZn39Pb3

Handle: plastic-coated aluminium

Safety nut: galvanized steel

Optional services on request

Durchgangshahn

mit Dichtkegelanschluss 60°

Robinet simple à passage direct

avec raccordement à étanchéité sur cône 60°

Total-flow cock

with cone seat connection 60°

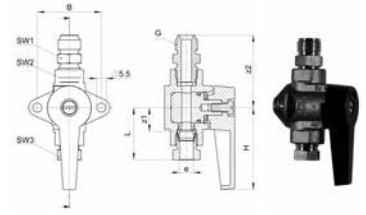

SO PV 08E01

Type -d-G	Mat.-Nr.	bar	SW1	SW2	SW3	L	B	H	z1	z2	e	kg/100
G=Rohrgewinde (zylindrisch)			G=Filetage-gaz BSP (cylindrique)				G=BSP thread (parallel)					
SO PV 08E01-6-1/4 F	258.7810.110	10	14	17	14	31.0	38.0	48.0	14.0	43.0	5.0	19.500
SO PV 08E01-6-3/8 F	258.7810.120	10	14	17	17	31.0	38.0	48.0	14.0	44.0	5.0	20.500
SO PV 08E01-8-1/4 F	258.7810.170	10	14	17	14	31.0	38.0	48.0	14.0	43.0	5.5	19.000
SO PV 08E01-8-3/8 F	258.7810.180	10	14	17	17	31.0	38.0	48.0	14.0	44.0	5.5	20.000

Temperatur max. +80°C

Dieser Durchgangshahn hat eine grosse Bohrung. Die Strömung erfährt weder Drosselung noch Umlenkung. Der Durchflusswiderstand ist somit unbedeutend. Der Griff zeigt eindeutig die geöffnete oder geschlossene Stellung an. Die Abdichtung der Bohrung erfolgt mit einer speziellen Dichtbuchse. Bei Ölheizungen wird dieser Hahn gerne als Feuerwehrrahn eingesetzt.

Geeignet für: Luft, Öle, Wasser

Technische Hinweise:

Ventilkörper, Walze und Anschlüsse aus Messing
Griff aus Kunststoff, Farbe schwarz,
auf Wunsch rot
Dichtbuchsen aus thermoplastischem PUR
O-Ring aus NBR

Température max. +80°C

Ce robinet possède un grand passage direct évitant ainsi tout étranglement ou toute déviation de l'écoulement. La résistance de passage est donc insignifiante. La manette indique clairement la position ouverte ou fermée. L'étanchéité sur le passage est réalisé par un joint spécial. Pour les chauffages à mazout, ce robinet s'installe judicieusement comme robinet coupe-feu.

Utilisable pour: air, huiles et eau

Données techniques:

Corps, boisseau cylindrique et écrous en laiton
Manette en matière plastique noir
(rouge sur demande)
Joint spécial en PUR
Joint torique en NBR

Temperature max. +80°C

This total-flow cock has a large bore the flow is neither throttled nor diverted. Flow resistance is therefore insignificant. The handle indicates clearly and logically the open or closed setting. The bore is sealed off with a special bush. In oil heating systems this cock is popular as a fire fighting accessory.

Suitable for air, oils, water

Technical notes:

Valve body, piston and connections of brass
Handle of black plastic; red on request
Bush seal of thermoplastic PUR
O-rings of NBR

Durchgangshahn

Robinet simple à passage direct

Total-flow cock

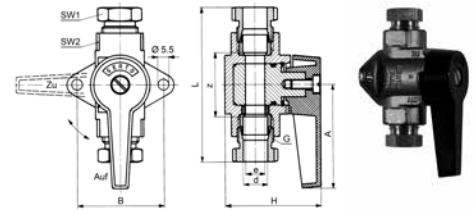

SO PV 08E21

Type -d	Mat.-Nr.	bar	G	SW1	SW2	L	A	H	B	z	e	kg/100
SO PV 08E21-6 F	258.7820.060	10	1/4	14	17	62.0	48.0	41.5	38.0	28.0	5.0	20.000
SO PV 08E21-8 F	258.7820.080	10	1/4	14	17	62.0	48.0	41.5	38.0	28.0	5.5	19.500

Temperatur max. +80°C

Dieser Durchgangshahn hat eine grosse Bohrung. Die Strömung erfährt weder Drosselung noch Umlenkung. Der Durchflusswiderstand ist somit unbedeutend. Der Griff zeigt eindeutig die geöffnete oder geschlossene Stellung an. Die Abdichtung der Bohrung erfolgt mit einer speziellen Dichtbuchse. Bei Ölheizungen wird dieser Hahn gerne als Feuerwehrahahn eingesetzt.

Geeignet für: Luft, Öle, Wasser

Technische Hinweise:

Ventilkörper, Walze und Anschlüsse aus Messing
Griff aus Kunststoff, Farbe schwarz,
auf Wunsch rot
Dichtbuchsen aus thermoplastischem PUR
O-Ring aus NBR

Température max. +80°C

Ce robinet possède un grand passage direct évitant ainsi tout étranglement ou toute déviation de l'écoulement. La résistance de passage est donc insignifiante. La manette indique clairement la position ouverte ou fermée. L'étanchéité sur le passage est réalisé par un joint spécial. Pour les chauffages à mazout, ce robinet s'installe judicieusement comme robinet coupe-feu.

Utilisable pour: air, huiles et eau

Données techniques:

Corps, boisseau cylindrique et écrous en laiton
Manette en matière plastique noir
(rouge sur demande)
Joint spécial en PU.
Joint torique en NBR

Temperature max. +80°C

This total-flow cock has a large bore the flow is neither throttled nor diverted. Flow resistance is therefore insignificant. The handle indicates clearly and logically the open or closed setting. The bore is sealed off with a special bush. In oil heating systems this cock is popular as a fire fighting accessory.

Suitable for air, oils, water

Technical notes:

Valve body, piston and connections of brass
Handle of black plastic; red on request
Bush seal of thermoplastic PUR
O-rings of NBR

F=Befestigungsflansch
d=Rohraussen-ø
e=kleinste Bohrung
L=Mass in montiertem Zustand
H=Ventil geöffnet

F=Flasque de fixation
d=ø extérieur du tube
e=ø-min. de passage
L=après montage
H=vanne ouvert

F=Model with flange mount
d=tube outside diameter
e=minimum bore
L=installed length
H=valve open

Regulier- / Feinregulierventil Robinet de réglage / réglage fin Regulating / fine regulating valve

SO NV 51A21/E/EB/EL
SO NV 51C21/E/EB/EL

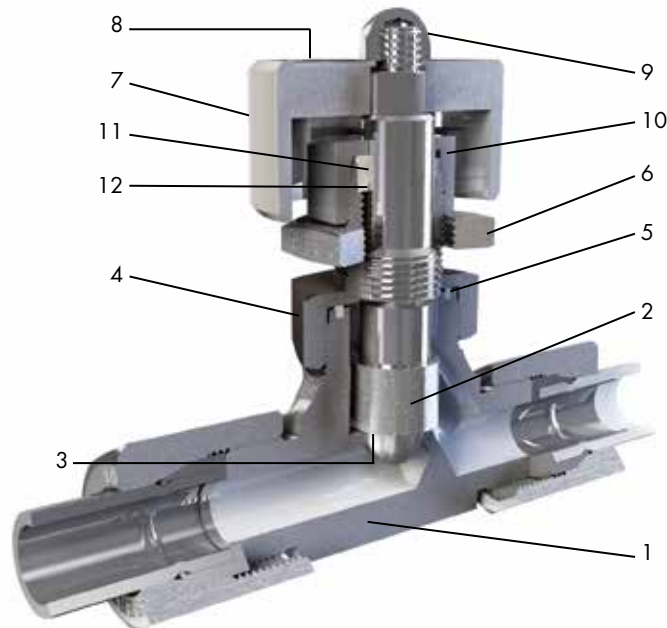

Nr. No. No.	Bezeichnung Désignation Description	Material Matériau Material	Nr. No. No.	Bezeichnung Désignation Description	Material Matériau Material	Nr. No. No.	Bezeichnung Désignation Description	Material Matériau Material
1	Ventilkörper Corps cône de soupape Valve body	1.4571	5	Dichtung Joint Seal	PTFE	9	Hutmutter Écrou borgne Cap nut	CW617N vern.
2	Ventilspindel Tige soupape Valve spindle	1.4571	6	Kontermutter Contre-écrou Counter nut	1.4571	10*	Ventilkappe Bouchon de soupape Valve cap	1.4571
3	Dichtung Joint Seal	PTFE 25 % GF	7	Handrad Manche Handwheel	Aluminium	11	Spindeldichtung Joint de la tige Spindle seal	PTFE 25 % GF
4	Schalttafeloberteil Partie sup. tableau de commande Panel top	1.4571	8*	Ventilschild (schwarz) Plaque indicatrice (noir) Valve label (black)	Aluminium	12	Unterlagsscheibe Rondelle Washer	1.4571

Spezifikationen

Betriebsdruck (PN): 64 bis 100 bar
Temperatur: -40°C bis +180°C
Sicherheitsfaktor: 1.5-fach

Merkmale

- Die kompakte Bauweise eignet sich für den Einbau auch bei engsten Platzverhältnissen.
- Die Konstruktion ist auf maximalen Durchfluss ausgelegt.

* Optionen

- Nr. 8 - Ventilschild: wahlweise auch in den Farben blau, rot, grün, gelb siehe VSD SO NV
- Nr. 10 - Drehmoment für Ventilkappe bei Schalttafelmontage:
Größen 3/5/6/8/1/8"/1/4" = 2 Nm
Größen 10/12/15/3/8" = 2.5 Nm
- Varianten: mit Übergangsmuffe SO 50030 oder Übergangsnippel SO 50040

Spécifications

Pression de service (PN): 64 à 100 bar
Température: -40°C à +180°C
Facteur de sécurité: 1.5 fois

Caractéristiques

- La conception compacte convient à un montage, même dans les endroits les plus étroits.
- La construction est conçue pour un écoulement maximal.

* Options

- No. 8 - Plaques indicatrices: au choix disponible en couleurs bleu, rouge, vert, jaune voir VSD SO NV
- No. 10 - Couple pour bouchon de soupape dans tableau de commande:
Dimensions 3/5/6/8/1/8"/1/4" = 2 Nm
Dimensions 10/12/15/3/8" = 2.5 Nm
- Autres versions: avec adaptateur femelle SO 50030 ou mâle SO 50040

Specifications

Working pressure (PN): 64 to 100 bar
Temperature: -40°C to +180°C
Safety factor: 1.5 times

Characteristics

- The compact design is ideal for installation even in the tightest spots.
- It has been constructed for maximum flow.

* Options

- No. 8 - Valve labels: also available in colors blue, red, green, yellow, see VSD SO NV
- No. 10 - Torque for valve cap in panel mounting:
Sizes 3/5/6/8/1/8"/1/4" = 2 Nm
Sizes 10/12/15/3/8" = 2.5 Nm
- Other versions: with female SO 50030 or male adaptor SO 50040

Durchflussdiagramm

Courbe de débit

Flow rate

Reguliventile / Robinets de réglage /
Regulating valves

Feinreguliventile / Robinets de réglage fin /
Fine regulating valves

SO NV 51A21

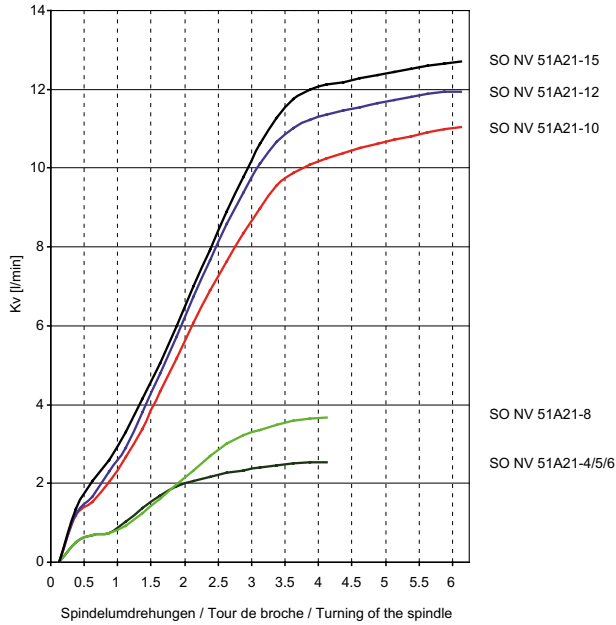

SO NV 51C21

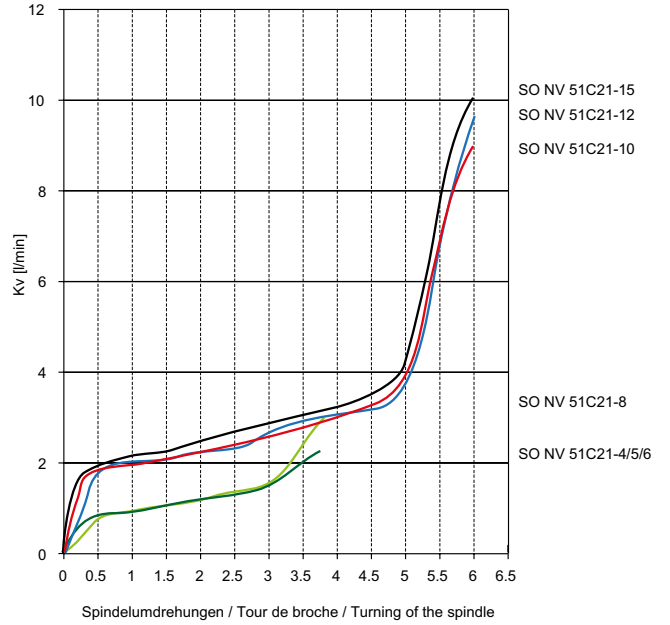

SO NV 51A21E / A21EB / A60EL

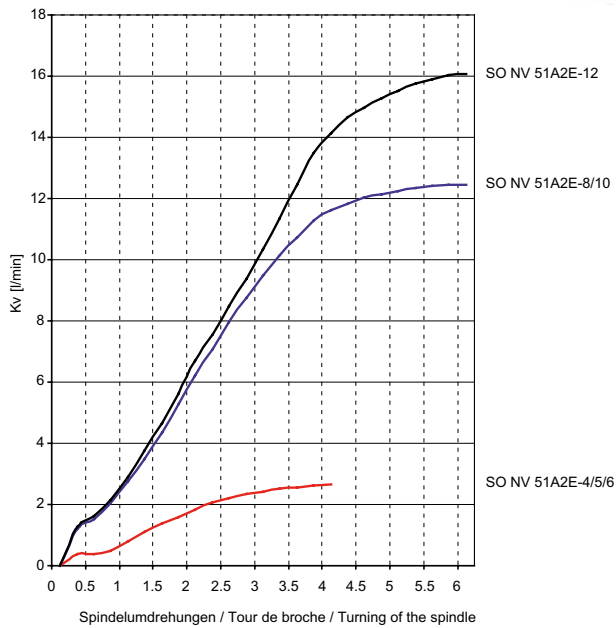

SO NV 51C21E / C21EB / C60EL

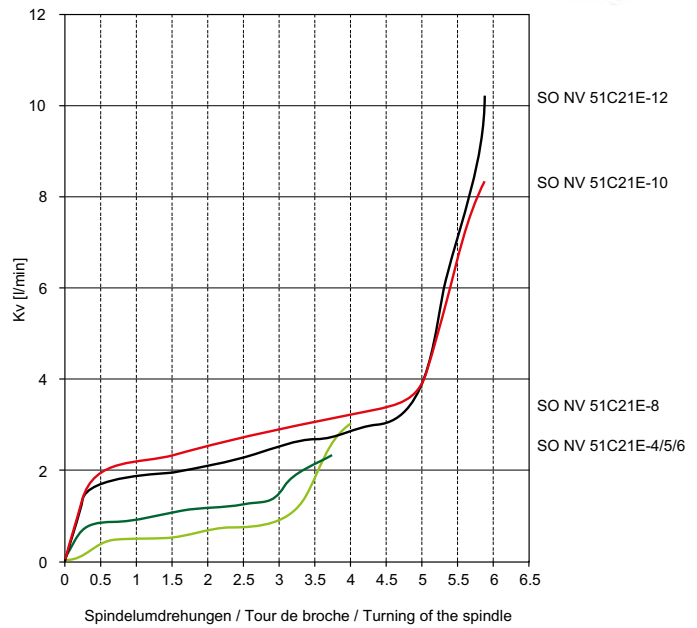

Sonderausführungen

siehe Kapitelübersicht

Exécutions en option

voir aperçu du chapitre

Optional services

see chapter overview

Reguliertventil

mit Innengewinde

Robinet de réglage

avec taraudage femelle

Regulating valve

with female thread

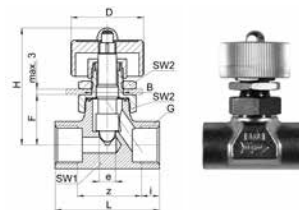

SO NV 51A00

Type -G	Mat.-Nr.	bar	SW1	SW2	L	D	H	B	F	i	z	e	kv	kg/100
G=Rohrgewinde (zylindrisch)			G=Filetage-gaz BSP (cylindrique)						G=BSP thread (parallel)					
SO NV 51A00-1/8	068.0001.020	100	14	14	32.0	20.0	37.0	10.0	14.5	8.5	15.0	3.5	3.5	4.900
SO NV 51A00-1/4	068.0001.040	100	22	14	34.0	20.0	39.0	10.0	16.5	9.5	15.0	3.5	3.5	7.800
SO NV 51A00-3/8	068.0001.060	64	24	22	46.0	32.0	52.0	14.5	22.5	10.0	26.0	7.0	10.5	17.200

Reguliertventil

Robinet de réglage

Regulating valve

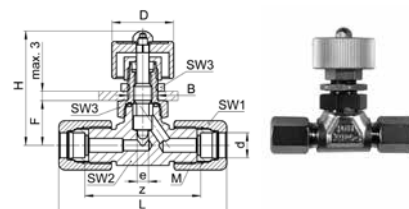

SO NV 51A21

Type -d	Mat.-Nr.	bar	M	SW1	SW2	SW3	L	D	H	B	F	z	e	kv	kg/100
Für metrische Rohre			Pour tubes métriques						For metric tubes						
★ SO NV 51A21-4	068.0011.040	100	10x1	12	14	14	50.0	20.0	37.0	10.0	14.5	34.0	3.5	3.0	6.900
★ SO NV 51A21-5	068.0011.050	100	10x1	12	14	14	50.0	20.0	37.0	10.0	14.5	34.0	3.5	3.2	6.800
SO NV 51A21-6	068.0011.060	100	10x1	12	14	14	50.0	20.0	37.0	10.0	14.5	34.0	3.5	3.5	6.500
SO NV 51A21-8	068.0011.080	100	12x1	14	14	14	54.0	20.0	37.0	10.0	14.5	37.5	3.5	3.5	8.200
SO NV 51A21-10	068.0011.100	64	14x1	17	22	22	70.0	32.0	50.5	14.5	21.5	47.5	7.0	10.5	19.000
SO NV 51A21-12	068.0011.120	64	16x1	19	22	22	72.0	32.0	50.5	14.5	21.0	47.5	7.0	12.5	20.000
★ SO NV 51A21-14	068.0011.140	64	20x1.5	24	24	22	80.0	32.0	51.5	14.5	22.0	52.0	7.0	12.5	30.000
SO NV 51A21-15	068.0011.150	64	20x1.5	24	24	22	79.0	32.0	51.5	14.5	22.0	51.5	7.0	12.5	29.500
Für Zollrohre			Pour tubes pouces						For inch tubes						
SO NV 51A21-6,35	068.0011.063	100	10x1	12	14	14	50.5	20.0	37.0	10.0	14.5	34.5	3.5	3.5	6.500
SO NV 51A21-9,52	068.0011.095	64	14x1	17	22	22	69.0	32.0	50.5	14.5	21.0	47.5	7.0	10.5	18.900
SO NV 51A21-12,7	068.0011.127	64	20x1.5	24	24	22	79.0	32.0	51.5	14.5	22.0	52.0	7.0	12.5	29.100
★ SO NV 51A21-13,5	068.0011.135	64	20x1.5	24	24	22	85.0	32.0	50.5	14.5	21.0	52.0	7.0	12.5	30.000

Umrechnung für "d" bei Zollrohren:

6,35 = 1/4
 9,52 = 3/8
 12,7 = 1/2
 13,5 = 17/32

Conversion de "d" pour tubes en pouces:

6,35 = 1/4
 9,52 = 3/8
 12,7 = 1/2
 13,5 = 17/32

Conversion for "d" for inch tubes:

6,35 = 1/4
 9,52 = 3/8
 12,7 = 1/2
 13,5 = 17/32

d=Rohraussen-ø

e=kleinste Bohrung

kv=Kenngröße für das Durchflussverhalten (l/min)

L=Mass in montiertem Zustand

*=mit reduziertem Klemmring

d=ø extérieur du tube

e=ø-min. de passage

kv=facteur d'écoulement (l/min)

L=après montage

*=avec bague de serrage de réduction

d=tube outside diameter

e=minimum bore

kv=flow factor (l/min)

L=installed length

*=with reduced compression ferrule

Regulierventil

mit Übergangsmuffe SO 50030

Robinet de réglage

avec adaptateur femelle SO 50030

Regulating valve

with female adaptor SO 50030

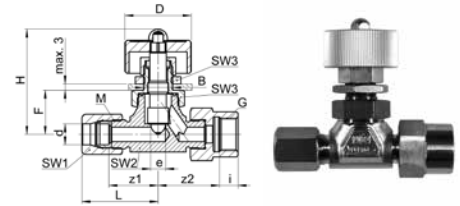
SO NV 51A30

Type -d-G	Mat.-Nr.	bar	M	SW1	SW2	SW3	L	H	F	i	z1	z2	e	kv	kg/100	
Für metrische Rohre			Pour tubes métriques							For metric tubes						
G=Rohrgewinde (zylindrisch)			G=Filetage-gaz BSP (cylindrique)							G=BSP thread (parallel)						
* SO NV 51A30-4-1/8	068.0012.060	100	10x1	12	14	14	25.0	37.0	14.5	10.0	17.0	20.0	3.5	3.0	8.460	
* SO NV 51A30-5-1/8	068.0012.082	100	10x1	12	14	14	25.0	37.0	14.5	10.0	17.0	20.0	3.5	3.2	8.360	
SO NV 51A30-6-1/8	068.0012.100	100	10x1	12	14	14	25.0	37.0	14.5	10.0	17.0	20.0	3.5	3.5	8.060	
SO NV 51A30-6-1/4	068.0012.110	100	10x1	12	14	14	25.0	37.0	14.5	11.0	17.0	20.0	3.5	3.5	8.060	
SO NV 51A30-8-1/8	068.0012.160	100	12x1	14	14	14	27.0	37.0	14.5	10.0	18.5	21.5	3.5	3.5	9.710	
SO NV 51A30-8-1/4	068.0012.170	100	12x1	14	14	14	27.0	37.0	14.5	12.0	18.5	21.5	3.5	3.5	9.300	
SO NV 51A30-8-3/8	068.0012.180	100	12x1	14	14	14	27.0	37.0	14.5	11.0	18.5	21.5	3.5	3.5	11.650	
SO NV 51A30-10-1/4	068.0012.270	64	14x1	17	22	22	35.0	51.0	21.5	12.0	23.5	26.5	7.0	10.5	19.090	
SO NV 51A30-10-3/8	068.0012.280	64	14x1	17	22	22	35.0	51.0	21.5	12.0	23.5	26.5	7.0	10.5	21.270	
SO NV 51A30-12-3/8	068.0012.390	64	16x1	19	22	22	36.0	51.0	21.0	12.0	23.5	26.5	7.0	12.5	21.510	
SO NV 51A30-12-1/2	068.0012.400	64	16x1	19	22	22	36.0	51.0	21.0	12.0	23.5	26.5	7.0	12.5	24.820	
SO NV 51A30-15-1/2	068.0012.534	64	20x1.5	24	24	22	40.0	52.0	22.0	12.0	26.0	29.5	7.0	12.5	31.890	

Für Zollrohre			Pour tubes pouces							For inch tubes						
SO NV 51A30-6,35-1/8	068.0012.135	100	10x1	12	14	14	25.0	37.0	14.5	10.0	17.0	20.0	3.5	3.5	7.320	
SO NV 51A30-9,52-1/4	068.0012.230	64	14x1	17	22	22	34.0	51.0	21.0	12.0	23.5	26.5	7.0	10.5	19.210	
SO NV 51A30-9,52-3/8	068.0012.235	64	14x1	17	22	22	37.0	51.0	21.0	12.0	23.5	26.5	7.0	12.5	21.390	
SO NV 51A30-12,7-1/2	068.0012.434	64	20x1.5	24	24	22	40.0	52.0	22.0	12.0	26.0	29.5	7.0	12.5	31.120	

Umrechnung für "d" bei Zollrohren:

 6,35 = 1/4
 9,52 = 3/8
 12,7 = 1/2

Conversion de "d" pour tubes en pouces:

 6,35 = 1/4
 9,52 = 3/8
 12,7 = 1/2

Conversion for "d" for inch tubes:

 6,35 = 1/4
 9,52 = 3/8
 12,7 = 1/2

 D = ø 20 mm ≤ Anschlussgröße 8
 ø 32 mm ≥ Anschlussgröße 9,52

 D = ø 20 mm ≤ Dimension 8
 ø 32 mm ≥ Dimension 9,52

 D = ø 20 mm ≤ Dimension 8
 ø 32 mm ≥ Dimension 9,52

 B = ø 10 mm ≤ Anschlussgröße 8
 ø 14,5 mm ≥ Anschlussgröße 9,52

 B = ø 10 mm ≤ Dimension 8
 ø 14,5 mm ≥ Dimension 9,52

 B = ø 10 mm ≤ Dimension 8
 ø 14,5 mm ≥ Dimension 9,52

 d=Rohrassen-ø
 e=kleinste Bohrung
 kv=Kenngröße für das Durchflussverhalten (l/min)
 L=Mass in montiertem Zustand
 *=mit reduziertem Klemmring

 d=ø extérieur du tube
 e=ø-min. de passage
 kv=facteur d'écoulement (l/min)
 L=après montage
 *=avec bague de serrage de réduction

 d=tube outside diameter
 e=minimum bore
 kv=flow factor (l/min)
 L=installed length
 *=with reduced compression ferrule

Regulierventil

mit Übergangsnippel SO 50040

Robinet de réglage

avec adaptateur mâle SO 50040

Regulating valve

with male adaptor SO 50040

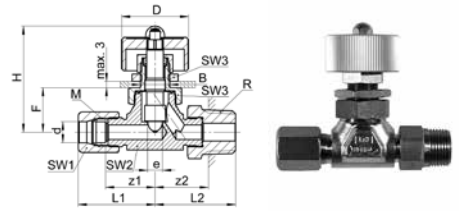
SO NV 51A40

Type -d -R	Mat.-Nr.	bar	M	SW1	SW2	SW3	L1	L2	H	F	z1	z2	e	kv	kg/100
Für metrische Rohre															
R=Rohrgewinde (kegelig)															
* SO NV 51A40-4-1/8	068.0014.060	100	10x1	12	14	14	25.0	27.0	37.0	14.5	17.0	20.5	3.5	3.0	6.850
* SO NV 51A40-4-1/4	068.0014.065	100	10x1	12	14	14	25.0	31.0	37.0	14.5	17.0	21.5	3.5	3.0	7.820
* SO NV 51A40-5-1/8	068.0014.082	100	10x1	12	14	14	25.0	27.0	37.0	14.5	17.0	20.5	3.5	3.2	6.750
* SO NV 51A40-5-1/4	068.0014.084	100	10x1	12	14	14	25.0	31.0	37.0	14.5	17.0	21.5	3.5	3.2	7.720
SO NV 51A40-6-1/8	068.0014.100	100	10x1	12	14	14	25.0	27.0	37.0	14.5	17.0	20.5	3.5	3.5	7.420
SO NV 51A40-6-1/4	068.0014.110	100	10x1	12	14	14	25.0	31.0	37.0	14.5	17.0	21.5	3.5	3.5	7.420
SO NV 51A40-8-1/8	068.0014.160	100	12x1	14	14	14	27.0	28.5	37.0	14.5	18.5	22.0	3.5	3.5	8.130
SO NV 51A40-8-1/4	068.0014.170	100	12x1	14	14	14	27.0	32.5	37.0	14.5	18.5	23.0	3.5	3.5	8.600
SO NV 51A40-8-3/8	068.0014.180	100	12x1	14	14	14	27.0	32.5	37.0	14.5	18.5	22.5	3.5	3.5	9.950
SO NV 51A40-8-1/2	068.0014.185	100	12x1	14	14	14	27.0	36.5	37.0	14.5	18.5	23.5	3.5	3.5	10.850
SO NV 51A40-10-1/4	068.0014.270	64	14x1	17	22	22	35.0	37.5	51.0	21.5	23.5	28.0	7.0	10.5	18.790
SO NV 51A40-10-3/8	068.0014.280	64	14x1	17	22	22	35.0	37.5	51.0	21.5	23.5	27.5	7.0	10.5	19.500
SO NV 51A40-10-1/2	068.0014.285	64	14x1	17	22	22	35.0	38.5	51.0	21.5	23.5	25.5	7.0	10.5	21.850
SO NV 51A40-12-1/4	068.0014.380	64	16x1	19	22	22	36.0	38.5	51.0	21.0	23.5	29.0	7.0	12.5	19.760
SO NV 51A40-12-3/8	068.0014.390	64	16x1	19	22	22	36.0	37.5	51.0	21.0	23.5	27.5	7.0	12.5	20.010
SO NV 51A40-12-1/2	068.0014.400	64	16x1	19	22	22	36.0	41.5	51.0	21.0	23.5	28.5	7.0	12.5	22.620
SO NV 51A40-15-1/2	068.0014.534	64	20x1.5	24	24	22	39.5	43.5	52.0	22.0	26.0	30.5	7.0	12.5	29.460

Für Zollrohre

Pour tubes pouces

For inch tubes

SO NV 51A40-6,35-1/8	068.0014.135	100	10x1	12	14	14	25.0	27.0	37.0	14.5	17.0	20.5	3.5	3.5	6.470
SO NV 51A40-6,35-1/4	068.0014.140	100	10x1	12	14	14	25.0	31.0	37.0	14.5	17.0	21.0	3.5	3.5	7.440
SO NV 51A40-9,52-1/4	068.0014.230	64	14x1	17	22	22	34.5	37.5	51.0	21.0	23.5	27.5	7.0	10.5	18.660
SO NV 51A40-9,52-3/8	068.0014.235	64	14x1	17	22	22	34.5	37.5	51.0	21.0	23.5	27.5	7.0	10.5	19.370
SO NV 51A40-9,52-1/2	068.0014.240	64	14x1	17	22	22	34.5	38.5	51.0	21.0	23.5	25.5	7.0	10.5	21.700
SO NV 51A40-12,7-1/2	068.0014.434	64	20x1.5	24	24	22	39.5	43.5	52.0	22.0	26.0	30.5	7.0	12.5	28.070

Umrechnung für "d" bei Zollrohren:

6,35 = 1/4

9,52 = 3/8

12,7 = 1/2

Conversion de "d" pour tubes en pouces:

6,35 = 1/4

9,52 = 3/8

12,7 = 1/2

Conversion for "d" for inch tubes:

6,35 = 1/4

9,52 = 3/8

12,7 = 1/2

 D = ø 20 mm ≤ Anschlussgröße 8
 ø 32 mm ≥ Anschlussgröße 9,52

 D = ø 20 mm ≤ Dimension 8
 ø 32 mm ≥ Dimension 9,52

 D = ø 20 mm ≤ Dimension 8
 ø 32 mm ≥ Dimension 9,52

 B = ø 10 mm ≤ Anschlussgröße 8
 ø 14,5 mm ≥ Anschlussgröße 9,52

 B = ø 10 mm ≤ Dimension 8
 ø 14,5 mm ≥ Dimension 9,52

 B = ø 10 mm ≤ Dimension 8
 ø 14,5 mm ≥ Dimension 9,52

d=Rohrassen-ø

e=kleinste Bohrung

kv=Kenngröße für das Durchflussverhalten (l/min)

L=Mass in montiertem Zustand

*=mit reduziertem Klemmring

d=ø extérieur du tube

e=ø-min. de passage

kv=facteur d'écoulement (l/min)

L=après montage

*=avec bague de serrage de réduction

d=tube outside diameter

e=minimum bore

kv=flow factor (l/min)

L=installed length

*=with reduced compression ferrule

Feinreguliertventil

mit Innengewinde

Robinet de réglage fin

avec taraudage femelle

Fine regulating valve

with female thread

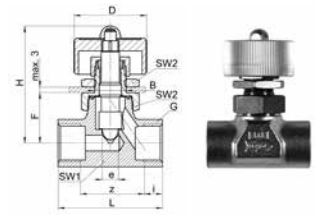
12

SO NV 51C00

Type -G	Mat.-Nr.	bar	SW1	SW2	L	D	H	B	F	i	z	e	kv	kg/100
G=Rohrgewinde (zylindrisch)			G=Filetage-gaz BSP (cylindrique)					G=BSP thread (parallel)						
SO NV 51C00-1/8	068.0101.020	100	14	14	32.0	20.0	37.0	10.0	14.5	8.5	15.0	3.5	3.5	5.200
SO NV 51C00-1/4	068.0101.040	100	22	14	34.0	20.0	39.0	10.0	16.5	9.5	15.0	3.5	3.5	8.100
SO NV 51C00-3/8	068.0101.060	64	24	22	46.0	32.0	52.0	14.5	22.5	10.0	26.0	7.0	10.5	19.000

Feinreguliertventil

Robinet de réglage fin

Fine regulating valve

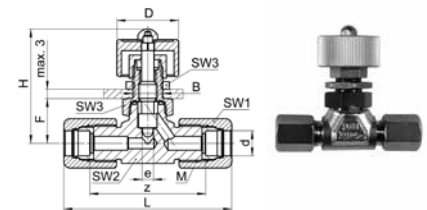

SO NV 51C21

Type -d	Mat.-Nr.	bar	M	SW1	SW2	SW3	L	D	H	B	F	z	e	kv	kg/100
Für metrische Rohre			Pour tubes métriques					For metric tubes							
★ SO NV 51C21-4	068.0111.040	100	10x1	12	14	14	50.0	20.0	36.0	10.0	14.5	34.0	3.5	3.5	7.200
★ SO NV 51C21-5	068.0111.050	100	10x1	12	14	14	50.0	20.0	37.0	10.0	14.5	34.0	3.5	3.5	7.100
SO NV 51C21-6	068.0111.060	100	10x1	12	14	14	50.0	20.0	37.0	10.0	14.5	34.0	3.5	3.5	7.200
SO NV 51C21-8	068.0111.080	100	12x1	14	14	14	54.0	20.0	37.0	10.0	14.5	37.5	3.5	3.5	8.600
SO NV 51C21-10	068.0111.100	64	14x1	17	19	22	70.0	32.0	51.0	14.5	21.5	47.5	7.0	7.0	20.800
SO NV 51C21-12	068.0111.120	64	16x1	19	19	22	72.0	32.0	50.5	14.5	21.0	47.5	7.0	7.0	21.900
★ SO NV 51C21-14	068.0111.140	64	20x1.5	24	24	22	80.0	32.0	51.5	14.5	22.0	52.0	7.0	7.0	31.700
SO NV 51C21-15	068.0111.150	64	20x1.5	24	24	22	79.0	32.0	51.5	14.5	22.0	51.5	7.0	7.0	31.200
Für Zollrohre			Pour tubes pouces					For inch tubes							
SO NV 51C21-6,35	068.0111.063	100	10x1	12	14	14	50.5	20.0	37.0	10.0	14.5	34.0	3.5	3.5	7.000
SO NV 51C21-9,52	068.0111.095	64	14x1	17	22	22	69.0	32.0	50.5	14.5	21.0	47.5	7.0	10.5	20.700
SO NV 51C21-12,7	068.0111.127	64	20x1.5	24	24	22	79.0	32.0	51.5	14.5	22.0	52.0	7.0	12.5	30.900
★ SO NV 51C21-13,5	068.0111.135	64	20x1.5	24	24	22	85.0	32.0	51.5	14.5	21.0	52.0	7.0	12.5	31.700

Umrechnung für "d" bei Zollrohren:

- 6,35 = 1/4
- 9,52 = 3/8
- 12,7 = 1/2
- 13,5 = 17/32

Conversion de "d" pour tubes en pouces:

- 6,35 = 1/4
- 9,52 = 3/8
- 12,7 = 1/2
- 13,5 = 17/32

Conversion for "d" for inch tubes:

- 6,35 = 1/4
- 9,52 = 3/8
- 12,7 = 1/2
- 13,5 = 17/32

d=Rohraussen-ø
 e=kleinste Bohrung
 kv=Kenngröße für das Durchflussverhalten (l/min)
 L=Mass in montiertem Zustand
 *=mit reduziertem Klemmring

d=ø extérieur du tube
 e=ø-min. de passage
 kv=facteur d'écoulement (l/min)
 L=après montage
 *=avec bague de serrage de réduction

d=tube outside diameter
 e=minimum bore
 kv=flow factor (l/min)
 L=installed length
 *=with reduced compression ferrule

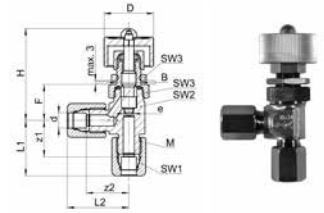
Regulier-Eckventil
Robinet-équerre de réglage
Elbow regulating valve

SO NV 51A21E

Type-d	Mat.-Nr.	bar	M	SW1	SW2	SW3	L1	L2	H	F	z1	z2	e	kv	kg/100	
Für metrische Rohre			Pour tubes métriques					For metric tubes								
* SO NV 51A21E-4	068.0020.040	100	10x1	12	14	14	22.5	25.0	36.0	14.5	14.5	17.0	3.5	4.5	6.600	
* SO NV 51A21E-5	068.0020.050	100	10x1	12	14	14	22.5	25.0	36.0	14.5	14.5	17.0	3.5	4.5	6.600	
SO NV 51A21E-6	068.0020.060	100	10x1	12	14	14	22.5	25.0	36.0	14.5	14.5	17.0	3.5	4.5	6.300	
* SO NV 51A21E-8	068.0020.080	64	14x1	17	22	22	28.5	35.0	51.0	21.5	17.5	24.0	6.5	4.5	18.300	
SO NV 51A21E-10	068.0020.100	64	14x1	17	22	22	28.5	35.0	51.0	21.5	17.0	23.5	7.0	12.5	17.600	
SO NV 51A21E-12	068.0020.120	64	16x1	19	22	22	30.5	36.0	51.0	21.5	18.0	23.5	7.0	12.5	18.800	

Für Zollrohre

Pour tubes pouces

For inch tubes

SO NV 51A21E-6,35	068.0020.063	100	10x1	12	14	14	22.5	25.0	36.0	14.5	14.5	17.0	3.5	4.5	6.300
SO NV 51A21E-9,52	068.0020.095	64	14x1	17	22	22	28.0	34.5	51.0	21.5	17.0	23.5	7.0	12.5	17.900

Umrechnung für "d" bei Zollrohren:

6,35 = 1/4

9,52 = 3/8

Conversion de "d" pour tubes en pouces:

6,35 = 1/4

9,52 = 3/8

Conversion for "d" for inch tubes:

6,35 = 1/4

9,52 = 3/8

 D = ø 20 mm ≤ Anschlussgröße 6,35
 ø 32 mm ≥ Anschlussgröße 8

 D = ø 20 mm ≤ Dimension 6,35
 ø 32 mm ≥ Dimension 8

 D = ø 20 mm ≤ Dimension 6,35
 ø 32 mm ≥ Dimension 8

 B = ø 10 mm ≤ Anschlussgröße 6,35
 ø 14,5 mm ≥ Anschlussgröße 8

 B = ø 10 mm ≤ Dimension 6,35
 ø 14,5 mm ≥ Dimension 8

 B = ø 10 mm ≤ Dimension 6,35
 ø 14,5 mm ≥ Dimension 8

d=Rohrassens-ø

e=kleinste Bohrung

kv=Kenngröße für das Durchflussverhalten (l/min)

L=Mass in montiertem Zustand

*=mit reduziertem Klemmring

d=ø extérieur du tube

e=ø-min. de passage

kv=facteur d'écoulement (l/min)

L=après montage

*=avec bague de serrage de réduction

d=tube outside diameter

e=minimum bore

kv=flow factor (l/min)

L=installed length

*=with reduced compression ferrule

Regulier-Eckventil

mit Übergangsmuffe SO 50030

Robinet-équerre de réglage

avec adaptateur femelle SO 50030

Elbow regulating valve

with female adaptor SO 50030

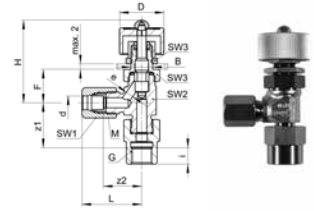
SO NV 51A30E

Type -d-G	Mat.-Nr.	bar	M	SW1	SW2	SW3	L	H	F	i	z1	z2	e	kv	kg/100
Für metrische Rohre															
G=Rohrgewinde (zylindrisch)															
* SO NV 51A30E-4-1/8	068.0022.060	100	10x1	12	14	14	25.0	37.0	14.5	7.5	20.0	17.0	3.5	4.5	7.290
* SO NV 51A30E-5-1/8	068.0022.082	100	10x1	12	14	14	25.0	37.0	14.5	7.5	20.0	17.0	3.5	4.5	7.290
SO NV 51A30E-6-1/8	068.0022.100	100	10x1	12	14	14	27.5	37.0	14.5	7.5	20.0	17.0	3.5	4.5	6.990
* SO NV 51A30E-8-1/4	068.0022.170	64	14x1	17	22	22	31.0	51.0	22.0	8.0	23.0	24.0	6.5	4.5	18.390
* SO NV 51A30E-8-3/8	068.0022.180	64	14x1	17	22	22	35.0	51.0	22.0	9.0	23.0	24.0	6.5	4.5	21.020
SO NV 51A30E-10-1/4	068.0022.270	64	14x1	17	22	22	35.0	51.0	22.0	8.0	23.0	24.0	7.0	12.5	17.690
SO NV 51A30E-10-3/8	068.0022.280	64	14x1	17	22	22	35.0	51.0	22.0	9.0	23.0	24.0	7.0	12.5	19.870
SO NV 51A30E-12-1/2	068.0022.400	64	16x1	19	22	22	36.0	51.0	21.5	9.5	25.5	24.0	7.0	12.5	23.620
Für Zollrohre															
SO NV 51A30E-6,35-1/8	068.0022.135	100	10x1	12	14	14	25.0	37.0	14.5	7.5	20.0	17.0	3.5	4.5	7.010
SO NV 51A30E-9,52-1/4	068.0022.230	64	14x1	17	22	22	34.5	51.0	22.0	8.0	23.0	24.0	7.0	12.5	17.960
SO NV 51A30E-9,52-3/8	068.0022.235	64	14x1	17	22	22	34.5	51.0	22.0	9.0	23.0	24.0	7.0	12.5	20.140

Umrechnung für "d" bei Zollrohren:

$6,35 = 1/4$

$9,52 = 3/8$

Conversion de "d" pour tubes en pouces:

$6,35 = 1/4$

$9,52 = 3/8$

Conversion for "d" for inch tubes:

$6,35 = 1/4$

$9,52 = 3/8$

$D = \varnothing 20 \text{ mm} \leq \text{Anschlussgrösse } 6,35$
 $\varnothing 32 \text{ mm} \geq \text{Anschlussgrösse } 8$

$D = \varnothing 20 \text{ mm} \leq \text{Dimension } 6,35$
 $\varnothing 32 \text{ mm} \geq \text{Dimension } 8$

$D = \varnothing 20 \text{ mm} \leq \text{Dimension } 6,35$
 $\varnothing 32 \text{ mm} \geq \text{Dimension } 8$

$B = \varnothing 10 \text{ mm} \leq \text{Anschlussgrösse } 6,35$
 $\varnothing 14,5 \text{ mm} \geq \text{Anschlussgrösse } 8$

$B = \varnothing 10 \text{ mm} \leq \text{Dimension } 6,35$
 $\varnothing 14,5 \text{ mm} \geq \text{Dimension } 8$

$B = \varnothing 10 \text{ mm} \leq \text{Dimension } 6,35$
 $\varnothing 14,5 \text{ mm} \geq \text{Dimension } 8$

d=Rohrassen-ø

e=kleinste Bohrung

kv=Kenngrösse für das Durchflussverhalten (l/min)

L=Mass in montiertem Zustand

*=mit reduziertem Klemmring

d=ø extérieur du tube

e=ø-min. de passage

kv=facteur d'écoulement (l/min)

L=après montage

*=avec bague de serrage de réduction

d=tube outside diameter

e=minimum bore

kv=flow factor (l/min)

L=installed length

*=with reduced compression ferrule

Regulier-Eckventil

mit Übergangsnippel SO 50040

Robinet-équerre de réglage

avec adaptateur mâle SO 50040

Elbow regulating valve

with male adaptor SO 50040

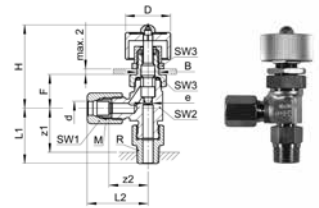
SO NV 51A40E

Type -d -R	Mat.-Nr.	bar	M	SW1	SW2	SW3	L1	L2	H	F	z1	z2	e	kv	kg/100	
Für metrische Rohre R=Rohrgewinde (kegelig)				Pour tubes métriques R=Filetage-gaz BSP (conique)							For metric tubes R=BSP thread (tapered)					
* SO NV 51A40E-4-1/4	068.0023.065	100	10x1	12	14	14	28.5	25.0	37.0	14.5	19.0	17.0	3.5	4.5	7.520	
* SO NV 51A40E-5-1/4	068.0023.084	100	10x1	12	14	14	28.5	25.0	37.0	14.5	19.0	17.0	3.5	4.5	7.520	
* SO NV 51A40E-8-3/8	068.0023.180	64	14x1	17	22	22	31.0	35.0	51.0	21.5	21.0	23.5	6.5	4.5	18.800	
* SO NV 51A40E-8-1/2	068.0023.185	64	14x1	17	22	22	32.0	35.0	51.0	21.5	19.0	23.5	6.5	4.5	21.130	
SO NV 51A40E-10-1/4	068.0023.270	64	14x1	17	22	22	31.0	35.0	51.0	22.0	21.5	23.5	7.0	12.5	17.390	
SO NV 51A40E-10-3/8	068.0023.280	64	14x1	17	22	22	31.0	35.0	51.0	22.0	21.0	23.5	7.0	12.5	18.100	
SO NV 51A40E-10-1/2	068.0023.285	64	14x1	17	22	22	32.0	35.0	51.0	22.0	19.0	23.5	7.0	12.5	20.430	
SO NV 51A40E-12-1/2	068.0023.400	64	16x1	19	22	22	36.0	36.0	51.0	21.5	23.0	23.5	7.0	12.5	21.420	
Für Zollrohre				Pour tubes pouces							For inch tubes					
SO NV 51A40E-9,52-1/4	068.0023.230	64	14x1	17	22	22	31.0	34.5	51.0	21.5	21.5	23.5	7.0	12.5	17.660	
SO NV 51A40E-9,52-3/8	068.0023.235	64	14x1	17	22	22	31.0	34.5	51.0	21.5	21.0	23.5	7.0	12.5	18.370	
SO NV 51A40E-9,52-1/2	068.0023.240	64	14x1	17	22	22	32.0	34.5	51.0	21.5	19.0	23.5	7.0	12.5	20.700	

 Umrechnung für "d" bei Zollrohren:
 $9,52 = 3/8$

 Conversion de "d" pour tubes en pouces:
 $9,52 = 3/8$

 Conversion for "d" for inch tubes:
 $9,52 = 3/8$
 $D = \varnothing 20 \text{ mm} \leq \text{Anschlussgrösse } 5$
 $\varnothing 32 \text{ mm} \geq \text{Anschlussgrösse } 8$
 $D = \varnothing 20 \text{ mm} \leq \text{Dimension } 5$
 $\varnothing 32 \text{ mm} \geq \text{Dimension } 8$
 $D = \varnothing 20 \text{ mm} \leq \text{Dimension } 5$
 $\varnothing 32 \text{ mm} \geq \text{Dimension } 8$
 $B = \varnothing 10 \text{ mm} \leq \text{Anschlussgrösse } 5$
 $\varnothing 14,5 \text{ mm} \geq \text{Anschlussgrösse } 8$
 $B = \varnothing 10 \text{ mm} \leq \text{Dimension } 5$
 $\varnothing 14,5 \text{ mm} \geq \text{Dimension } 8$
 $B = \varnothing 10 \text{ mm} \leq \text{Dimension } 5$
 $\varnothing 14,5 \text{ mm} \geq \text{Dimension } 8$

d=Rohraussen- \varnothing
 e=kleinste Bohrung
 kv=Kenngrösse für das Durchflussverhalten (l/min)
 L=Mass in montiertem Zustand
 *=mit reduziertem Klemmring

d= \varnothing extérieur du tube
 e= \varnothing -min. de passage
 kv=facteur d'écoulement (l/min)
 L=après montage
 *=avec bague de serrage de réduction

d=tube outside diameter
 e=minimum bore
 kv=flow factor (l/min)
 L=installed length
 *=with reduced compression ferrule

Regulier-Eckventil

mit Einschraubgewinde

Robinet-équerre de réglage

avec filetage mâle

Elbow regulating valve

with male thread

SO NV 51A21EB

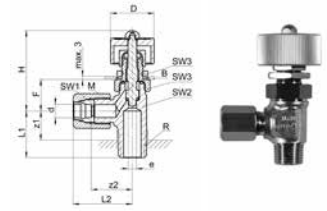

Type -d -R	Mat.-Nr.	bar	M	SW1	SW2	SW3	L1	L2	H	F	z1	z2	e	kv	kg/100	
Für metrische Rohre R=Rohrgewinde (kegelig)		Pour tubes métriques R=Filetage-gaz BSP (conique)						For metric tubes R=BSP thread (tapered)								
* SO NV 51A21EB-4-1/8	068.0021.060	100	10x1	12	14	14	14.5	25.0	36.0	14.5	9.5	17.0	3.5	3.0	5.700	
* SO NV 51A21EB-5-1/8	068.0021.082	100	10x1	12	14	14	14.5	25.0	36.0	14.5	9.5	17.0	3.5	3.2	5.600	
SO NV 51A21EB-6-1/8	068.0021.100	100	10x1	12	14	14	14.5	25.0	36.0	14.5	9.5	17.0	3.5	3.5	5.500	
* SO NV 51A21EB-6-1/4	068.0021.110	100	12x1	14	14	14	21.5	27.0	36.0	14.5	13.5	19.0	5.0	3.5	6.700	
SO NV 51A21EB-8-1/4	068.0021.170	100	12x1	14	14	14	21.5	27.0	36.0	14.5	13.5	18.0	3.5	3.5	6.400	
SO NV 51A21EB-10-3/8	068.0021.280	64	14x1	17	22	22	22.0	35.0	51.0	21.5	14.0	23.0	7.0	10.5	16.300	
SO NV 51A21EB-12-3/8	068.0021.390	64	16x1	19	22	22	24.0	36.0	51.0	21.5	16.0	23.0	7.0	12.5	17.200	

Für Zollrohre

Pour tubes pouces

For inch tubes

SO NV 51A21EB-6,35-1/8	068.0021.135	100	10x1	12	14	14	14.5	25.0	36.0	14.5	9.5	17.0	3.5	3.5	5.500
SO NV 51A21EB-9,52-3/8	068.0021.235	64	14x1	17	22	22	22.0	34.5	51.0	21.5	14.0	23.5	7.0	10.5	16.500

Umrechnung für "d" bei Zollrohren:

$$6,35 = 1/4$$

$$9,52 = 3/8$$

Conversion de "d" pour tubes en pouces:

$$6,35 = 1/4$$

$$9,52 = 3/8$$

Conversion for "d" for inch tubes:

$$6,35 = 1/4$$

$$9,52 = 3/8$$

 D = \varnothing 20 mm \leq Anschlussgröße 8
 \varnothing 32 mm \geq Anschlussgröße 9,52

 D = \varnothing 20 mm \leq Dimension 8
 \varnothing 32 mm \geq Dimension 9,52

 D = \varnothing 20 mm \leq Dimension 8
 \varnothing 32 mm \geq Dimension 9,52

 B = \varnothing 10 mm \leq Anschlussgröße 8
 \varnothing 14,5 mm \geq Anschlussgröße 9,52

 B = \varnothing 10 mm \leq Dimension 8
 \varnothing 14,5 mm \geq Dimension 9,52

 B = \varnothing 10 mm \leq Dimension 8
 \varnothing 14,5 mm \geq Dimension 9,52

Regulier-Eckventil

mit Einstellzapfen

Robinet-équerre de réglage

orientable

Elbow regulating valve

adjustable

SO NV 51A60EL

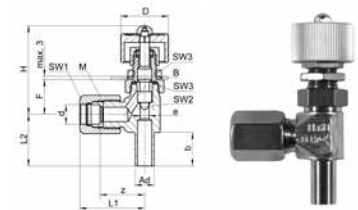

Type -d -Ad	Mat.-Nr.	bar	M	SW1	SW2	SW3	L1	L2	H	F	b	z	e	kv	kg/100
SO NV 51A60EL-6-A6	068.0026.060	100	10x1	12	14	14	20.5	27.5	37.0	14.5	13.0	19.5	3.5	3.5	6.310
SO NV 51A60EL-8-A8	068.0026.080	100	12x1	14	14	14	20.5	27.0	37.0	14.5	14.0	18.5	3.5	3.5	6.670

 D = \varnothing 20 mm

 B = \varnothing 10 mm

 D = \varnothing 20 mm

 B = \varnothing 10 mm

 D = \varnothing 20 mm

 B = \varnothing 10 mm

 d=Rohrassen- \varnothing

 Ad=Aussen- \varnothing der Andrehung

kv=Kenngröße für das Durchflussverhalten (l/min)

L=Mass in montiertem Zustand

*=mit reduziertem Klemmring

 d= \varnothing extérieur du tube

 Ad= \varnothing extérieur de la portée cylindrique

kv=facteur d'écoulement (l/min)

L=après montage

*=avec bague de serrage de réduction

d=tube outside diameter

Ad=outside diameter of cyl. stub

kv=flow factor (l/min)

L=installed length

*=with reduced compression ferrule

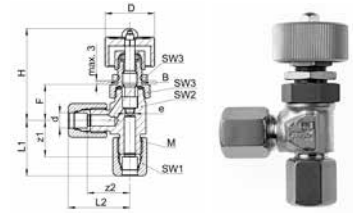
Feinregulier-Eckventil
Robinet-équerre de réglage fin
Elbow fine regulating valve

SO NV 51C21E

Type-d	Mat.-Nr.	bar	M	SW1	SW2	SW3	L1	L2	H	F	z1	z2	e	kv	kg/100	
Für metrische Rohre			Pour tubes métriques					For metric tubes								
* SO NV 51C21E-4	068.0120.040	100	10x1	12	14	14	22.5	25.0	36.0	14.5	14.5	17.0	3.5	4.5	7.100	
* SO NV 51C21E-5	068.0120.050	100	10x1	12	14	14	22.5	25.0	36.0	14.5	14.5	17.0	3.5	4.5	7.000	
SO NV 51C21E-6	068.0120.060	100	10x1	12	14	14	22.5	25.0	37.0	14.5	14.5	17.0	3.5	4.5	6.700	
* SO NV 51C21E-8	068.0120.080	64	14x1	17	22	22	28.5	35.0	51.0	21.5	17.5	24.0	6.5	4.5	20.300	
SO NV 51C21E-10	068.0120.100	64	14x1	17	22	22	28.5	35.0	51.0	21.5	17.0	23.5	7.0	12.5	19.400	
SO NV 51C21E-12	068.0120.120	64	16x1	19	22	22	30.5	36.0	51.0	21.5	18.0	23.5	7.0	12.5	21.200	

Für Zollrohre

Pour tubes pouces

For inch tubes

SO NV 51C21E-6,35	068.0120.063	100	10x1	12	14	14	22.5	25.0	36.0	14.5	14.5	17.0	3.5	4.5	6.700
SO NV 51C21E-9,52	068.0120.095	64	14x1	17	22	22	28.0	34.5	51.0	21.5	17.0	23.5	7.0	12.5	19.800

Umrechnung für "d" bei Zollrohren:

6,35 = 1/4

9,52 = 3/8

Conversion de "d" pour tubes en pouces:

6,35 = 1/4

9,52 = 3/8

Conversion for "d" for inch tubes:

6,35 = 1/4

9,52 = 3/8

 D = ø 20 mm ≤ Anschlussgröße 6,35
 ø 32 mm ≥ Anschlussgröße 8

 D = ø 20 mm ≤ Dimension 6,35
 ø 32 mm ≥ Dimension 8

 D = ø 20 mm ≤ Dimension 6,35
 ø 32 mm ≥ Dimension 8

 B = ø 10 mm ≤ Anschlussgröße 6,35
 ø 14,5 mm ≥ Anschlussgröße 8

 B = ø 10 mm ≤ Dimension 6,35
 ø 14,5 mm ≥ Dimension 8

 B = ø 10 mm ≤ Dimension 6,35
 ø 14,5 mm ≥ Dimension 8

d=Rohrassens-ø

e=kleinste Bohrung

kv=Kenngröße für das Durchflussverhalten (l/min)

L=Mass in montiertem Zustand

*=mit reduziertem Klemmring

d=ø extérieur du tube

e=ø-min. de passage

kv=facteur d'écoulement (l/min)

L=après montage

*=avec bague de serrage de réduction

d=tube outside diameter

e=minimum bore

kv=flow factor (l/min)

L=installed length

*=with reduced compression ferrule

Feinregulier-Eckventil

mit Einschraubgewinde

Robinet-équerre de réglage fin

avec filetage mâle

Elbow fine regulating valve

with male thread

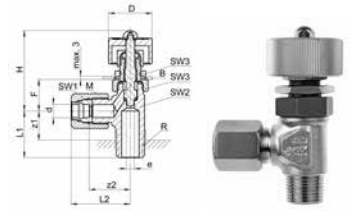
SO NV 51C21EB

Type -d -R	Mat.-Nr.	bar	M	SW1	SW2	SW3	L1	L2	H	F	z1	z2	e	kv	kg/100	
Für metrische Rohre R=Rohrgewinde (kegelig)		Pour tubes métriques R=Filetage-gaz BSP (conique)						For metric tubes R=BSP thread (tapered)								
* SO NV 51C21EB-4-1/8	068.0121.060	100	10x1	12	14	14	14.5	25.0	36.0	14.5	9.5	17.0	3.5	3.0	5.700	
* SO NV 51C21EB-5-1/8	068.0121.082	100	10x1	12	14	14	14.5	25.0	36.0	14.5	9.5	17.0	3.5	3.2	6.100	
SO NV 51C21EB-6-1/8	068.0121.100	100	10x1	12	14	14	14.5	25.0	37.0	14.5	9.5	17.0	3.5	3.2	5.900	
* SO NV 51C21EB-6-1/4	068.0121.110	100	12x1	14	14	14	21.5	27.0	37.0	14.5	13.5	18.0	3.5	3.5	7.200	
SO NV 51C21EB-8-1/4	068.0121.170	100	12x1	14	14	14	21.5	27.0	37.0	14.5	13.5	18.0	3.5	3.5	6.900	
SO NV 51C21EB-10-3/8	068.0121.280	64	14x1	17	22	22	22.0	35.0	51.0	21.5	14.0	23.0	7.0	10.5	18.200	
SO NV 51C21EB-12-3/8	068.0121.390	64	16x1	19	22	22	24.0	36.0	51.0	21.5	16.0	23.0	7.0	12.5	19.400	

Für Zollrohre		Pour tubes pouces						For inch tubes								
SO NV 51C21EB-6,35-1/8	068.0121.135	100	10x1	12	14	14	14.5	25.0	36.0	14.5	9.5	17.0	3.5	3.5	5.900	
SO NV 51C21EB-9,52-3/8	068.0121.235	64	14x1	17	22	22	22.0	34.5	51.0	21.5	14.0	23.5	7.0	10.5	18.400	

Umrechnung für "d" bei Zollrohren:

$6,35 = 1/4$

$9,52 = 3/8$

Conversion de "d" pour tubes en pouces:

$6,35 = 1/4$

$9,52 = 3/8$

Conversion for "d" for inch tubes:

$6,35 = 1/4$

$9,52 = 3/8$

 D = ø 20 mm ≤ Anschlussgröße 8
 ø 32 mm ≥ Anschlussgröße 9,52

 D = ø 20 mm ≤ Dimension 8
 ø 32 mm ≥ Dimension 9,52

 D = ø 20 mm ≤ Dimension 8
 ø 32 mm ≥ Dimension 9,52

 B = ø 10 mm ≤ Anschlussgröße 8
 ø 14,5 mm ≥ Anschlussgröße 9,52

 B = ø 10 mm ≤ Dimension 8
 ø 14,5 mm ≥ Dimension 9,52

 B = ø 10 mm ≤ Dimension 8
 ø 14,5 mm ≥ Dimension 9,52

Feinregulier-Eckventil

mit Einstellzapfen

Robinet-équerre de réglage fin

orientable

Elbow fine regulating valve

adjustable

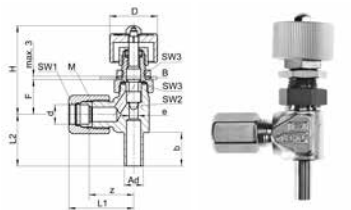
SO NV 51C60EL

Type -d -Ad	Mat.-Nr.	bar	M	SW1	SW2	SW3	L1	L2	H	F	b	z	e	kv	kg/100
SO NV 51C60EL-6-A6	068.0126.060	100	10x1	12	14	14	20.5	27.5	37.0	14.5	13.0	19.5	3.5	3.5	5.900
SO NV 51C60EL-8-A8	068.0126.080	100	12x1	14	14	14	20.5	27.0	37.0	14.5	14.0	18.5	3.5	3.5	6.600

D = ø 20 mm

B = ø 10 mm

D = ø 20 mm

B = ø 10 mm

D = ø 20 mm

B = ø 10 mm

d=Rohrassen-ø

Ad=Aussen-ø der Andrehung

kv=Kenngröße für das Durchflussverhalten (l/min)

L=Mass in montiertem Zustand

*=mit reduziertem Klemmring

d=ø extérieur du tube

Ad=ø extérieur de la portée cylindrique

kv=facteur d'écoulement (l/min)

L=après montage

*=avec bague de serrage de réduction

d=tube outside diameter

Ad=outside diameter of cyl. stub

kv=flow factor (l/min)

L=installed length

*=with reduced compression ferrule

Kegelrückschlagventil

Soupape de retenue à siège conique

Taper seat non-return valve

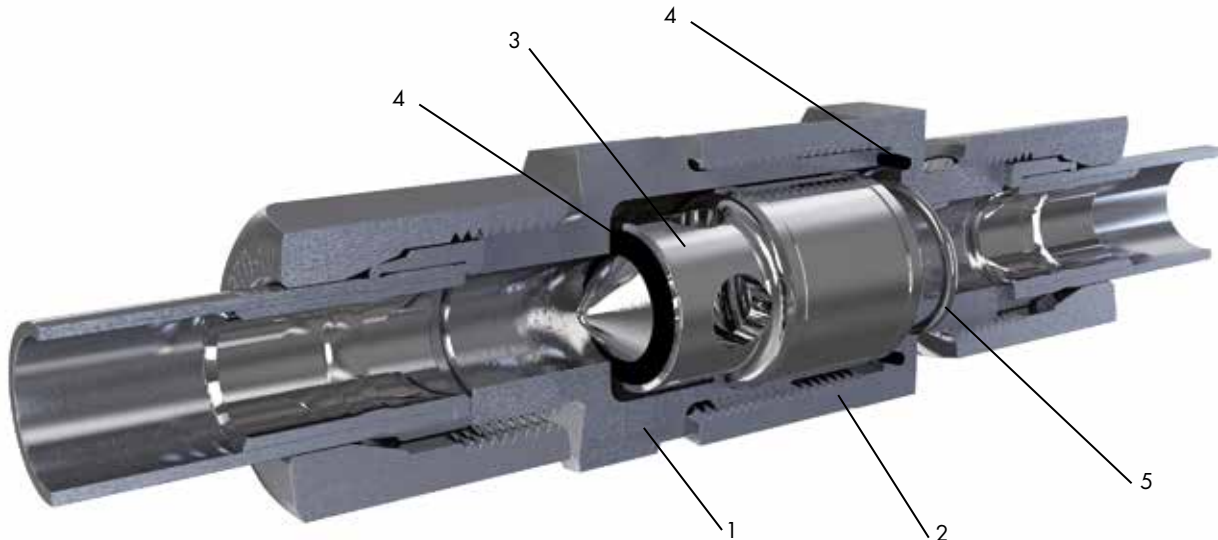
SO CV 53B21

Nr. No. No.	Bezeichnung Désignation Description	Material Matériau Material	Nr. No. No.	Bezeichnung Désignation Description	Material Matériau Material	Nr. No. No.	Bezeichnung Désignation Description	Material Matériau Material
1	Ventilkegelführung Guidage de cône de soupape Valve cone guide	1.4571	3	Ventilkegel Cône de soupape Valve cone	1.4571	5*	Druckfeder Ressort de compression Compression spring	1.4401
2	Ventilmutter Écrou de soupape Valve nut	1.4571	4*	Dichtung Joint Seal	FKM			

Spezifikationen

Betriebsdruck (PN): 100 bis 200 bar
 Temperatur: -20°C bis +180°C
 Öffnungsdruck: 1 bar +/- 20 %
 Sicherheitsfaktor: 1.5-fach

Merkmale

- Funktion: Rückflussverhinderer
- Einsatz: Luft, Öle und Flüssiggase (Beständigkeit Dichtung beachten)
- Material: Edelstahl 1.4571

*** Optionen**

- Nr. 4 - Dichtung: EPDM, FFKM
- Nr. 5 - Druckfeder: Öffnungsdruck 0.2, 0.5, 2, 3 bar, +/- 20 %
- Varianten: mit Übergangsmuffe SO 50030 oder Übergangsnippel SO 50040

Spécifications

Pression de service (PN): 100 à 200 bar
 Température: -20°C à +180°C
 Pression d'ouverture: 1 bar +/- 20 %
 Facteur de sécurité: 1.5 fois

Caractéristiques

- Fonction: clapet anti-retour
- Application: air, huiles et gaz liquéfiés (tenir compte de la résistance de l'étanchéité)
- Matériau: acier inoxydable 1.4571

*** Options**

- No. 4 - Joint: EPDM, FFKM
- No. 5 - Ressort de compression: pression d'ouverture 0.2, 0.5, 2, 3 bar, +/- 20 %
- Autres versions: avec adaptateur femelle SO 50030 ou mâle SO 50040

Specifications

Working pressure (PN): 100 to 200 bar
 Temperature: -20°C to +180°C
 Opening pressure: 1 bar +/- 20 %
 Safety factor: 1.5 times

Characteristics

- Function: check valve
- Uses: air, oils and liquid gases (check resistance of seal)
- Material: stainless steel 1.4571

*** Options**

- No. 4 - Seal: EPDM, FFKM
- No. 5 - Compression spring: opening pressure 0.2, 0.5, 2, 3 bar, +/- 20 %
- Other versions: with female SO 50030 or male adaptor SO 50040

Durchflussdiagramm

Der Druckabfall nimmt mit zunehmendem Durchfluss überproportional zu.

Courbe de débit

La perte de pression augmente disproportionnellement avec plus de débit.

Flow rate

The pressure drop increases disproportionately with increasing flow rate.

SO CV 53B21

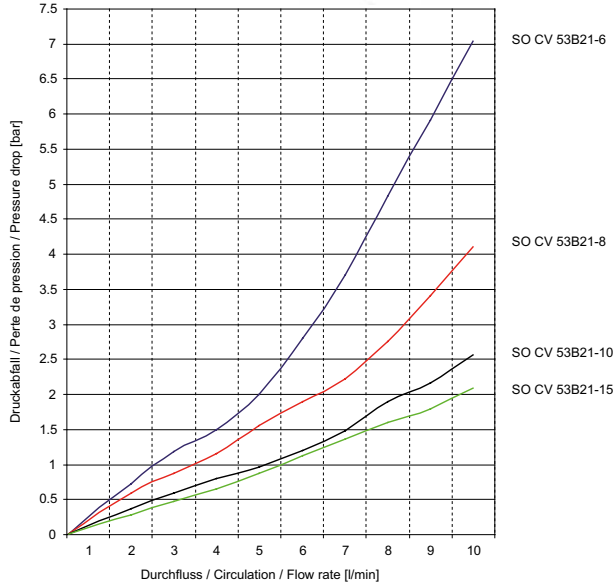

Öffnungsdruckdiagramm

Der Öffnungsdruck bewegt sich im blau skizzierten Bereich. Das Ventil schliesst im rot skizzierten Bereich.

Courbe de pression d'ouverture

La pression d'ouverture se trouve dans la zone indiquée en bleu. La vanne se ferme dans la zone indiquée en rouge.

Opening pressure diagram

The opening pressure ranges within the blue section. The valve closes within the red section.

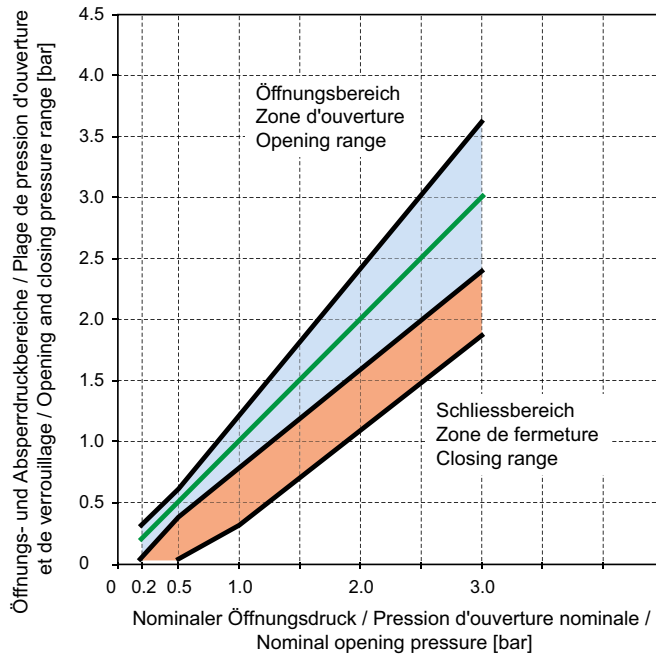

Sonderausführungen

siehe Kapitelübersicht

Exécutions en option

voir aperçu du chapitre

Optional services

see chapter overview

Kegelrückschlagventil

mit Innengewinde

Soupape de retenue à siège conique

avec taraudage femelle

Taper seat non-return valve

with female thread

SO CV 53B00

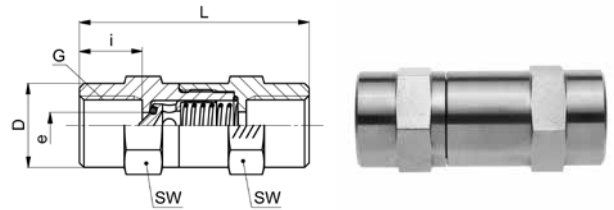

Type-d	Mat.-Nr.	bar	SW	L	D	i	e	kg/100
G=Rohrgewinde (zylindrisch)	G=Filetage-gaz BSP (cylindrique)	G=BSP thread (parallel)						
SO CV 53B00-1/8	068.3100.020	400	17	42.5	17.0	10.0	4.0	6.000
SO CV 53B00-1/4	068.3100.040	400	19	51.0	19.0	14.0	6.0	8.100
SO CV 53B00-3/8	068.3100.060	400	24	60.0	24.0	14.0	7.5	18.100
SO CV 53B00-1/2	068.3100.080	315	30	72.0	30.0	18.0	11.0	26.600
SO CV 53B00-3/4	068.3100.120	250	36	84.0	36.0	20.0	14.0	45.000
SO CV 53B00-1	068.3100.160	250	46	95.0	46.0	23.0	18.0	81.700

Kegelrückschlagventil

Soupape de retenue à siège conique

Taper seat non-return valve

SO CV 53B21

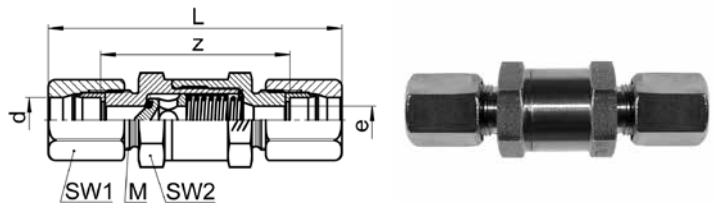

Type-d	Mat.-Nr.	bar	M	SW1	SW2	L	z	e	kg/100
Für metrische Rohre	Pour tubes métriques	For metric tubes							
* SO CV 53B21-4	068.3010.040	200	10x1	12	17	53.5	38.5	3.0	6.000
* SO CV 53B21-5	068.3010.050	200	10x1	12	17	53.5	38.5	3.8	6.000
SO CV 53B21-6	068.3010.060	200	10x1	12	17	53.5	38.5	3.8	5.900
SO CV 53B21-8	068.3010.080	200	12x1	14	19	60.5	44.0	5.8	8.000
SO CV 53B21-10	068.3010.100	160	14x1	17	22	73.5	51.0	7.5	13.000
SO CV 53B21-12	068.3010.120	100	16x1	19	22	75.5	51.0	7.5	28.000
* SO CV 53B21-14	068.3010.140	100	20x1.5	24	30	86.5	58.5	11.0	27.000
SO CV 53B21-15	068.3010.150	100	20x1.5	24	30	86.5	58.5	11.0	28.000
Für Zollrohre	Pour tubes pouces	For inch tubes							
SO CV 53B21-6,35	068.3010.063	200	10x1	12	17	53.5	38.5	3.8	5.900
SO CV 53B21-9,52	068.3010.095	160	14x1	17	22	73.5	51.0	7.5	13.000
* SO CV 53B21-12,7	068.3010.127	100	20x1.5	24	30	86.5	58.5	11.0	27.000

Umrechnung für "d" bei Zollrohren:

6,35 = 1/4

9,52 = 3/8

12,7 = 1/2

Conversion de "d" pour tubes en pouces:

6,35 = 1/4

9,52 = 3/8

12,7 = 1/2

Conversion for "d" for inch tubes:

6,35 = 1/4

9,52 = 3/8

12,7 = 1/2

d=Rohrassens-ø

kv=Kenngröße für das Durchflussverhalten (l/min)

L=Mass in montiertem Zustand

*=mit reduziertem Klemmring

d=ø extérieur du tube

kv=facteur d'écoulement (l/min)

L=après montage

*=avec bague de serrage de réduction

d=tube outside diameter

kv=flow factor (l/min)

L=installed length

*=with reduced compression ferrule

Kegelrückschlagventil

mit Übergangsmuffe SO 50030

Soupape de retenue à siège conique

avec adaptateur femelle SO 50030

Taper seat non-return valve

with female adaptor SO 50030

SO CV 53B30

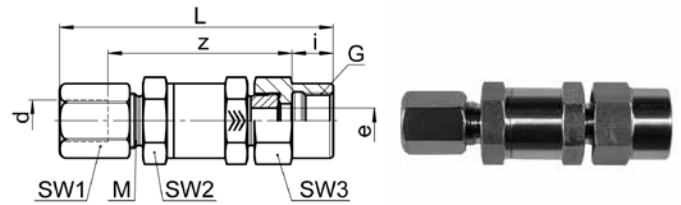

Type-d-G	Mat.-Nr.	bar	M	SW1	SW2	SW3	L	i	z	e	kg/100
Für metrische Rohre	Pour tubes métriques			For metric tubes							
G=Rohrgewinde (zylindrisch)	G=Filetage-gaz BSP (cylindrique)			G=BSP thread (parallel)							
★ SO CV 53B30-4-1/8	068.3011.060	200	10x1	12	17	14	59.0	10.0	41.5	3.5	6.000
★ SO CV 53B30-5-1/8	068.3011.082	200	10x1	12	17	14	59.0	10.0	41.5	3.8	6.000
SO CV 53B30-6-1/8	068.3011.100	200	10x1	12	17	14	59.0	10.0	41.5	3.8	6.000
SO CV 53B30-6-1/4	068.3011.110	200	10x1	12	17	17	66.5	11.0	46.5	3.8	7.000
SO CV 53B30-8-1/8	068.3011.160	200	12x1	14	19	17	65.0	10.0	46.5	5.8	8.900
SO CV 53B30-8-1/4	068.3011.170	200	12x1	14	19	17	67.0	12.0	48.0	5.8	8.500
SO CV 53B30-8-3/8	068.3011.180	160	12x1	14	19	22	67.0	11.0	46.5	5.8	10.000
SO CV 53B30-10-1/4	068.3011.270	160	14x1	17	22	17	76.0	12.0	53.5	7.5	12.000
SO CV 53B30-10-3/8	068.3011.280	160	14x1	17	22	22	77.0	12.0	53.5	7.5	14.000
SO CV 53B30-12-1/2	068.3011.400	160	16x1	19	22	27	79.0	12.0	53.5	7.5	18.000
★ SO CV 53B30-14-1/2	068.3011.504	100	20x1.5	24	30	27	95.0	12.0	67.5	11.0	28.700
SO CV 53B30-15-1/2	068.3011.534	100	20x1.5	24	30	27	90.0	12.0	62.5	11.0	28.000
SO CV 53B30-15-3/4	068.3011.536	100	20x1.5	24	30	32	98.0	15.0	67.5	11.0	32.500

Für Zollrohre

Pour tubes pouces

For inch tubes

SO CV 53B30-6,35-1/8	068.3011.135	200	10x1	12	17	14	59.0	10.0	41.5	3.8	6.000
SO CV 53B30-9,52-1/4	068.3011.230	160	14x1	17	22	17	76.0	12.0	53.5	7.5	12.000
SO CV 53B30-9,52-3/8	068.3011.235	160	14x1	17	22	22	77.0	12.0	53.5	7.5	14.000
SO CV 53B30-12,7-1/2	068.3011.434	100	20x1.5	24	30	27	90.0	12.0	62.5	11.0	28.000

Umrechnung für "d" bei Zollrohren:

 6,35 = 1/4
 9,52 = 3/8
 12,7 = 1/2

Conversion de "d" pour tubes en pouces:

 6,35 = 1/4
 9,52 = 3/8
 12,7 = 1/2

Conversion for "d" for inch tubes:

 6,35 = 1/4
 9,52 = 3/8
 12,7 = 1/2

d=Rohraussen-ø

kv=Kenngröße für das Durchflussverhalten (l/min)

L=Mass in montiertem Zustand

*=mit reduziertem Klemmring

d=ø extérieur du tube

kv=facteur d'écoulement (l/min)

L=après montage

*=avec bague de serrage de réduction

d=tube outside diameter

kv=flow factor (l/min)

L=installed length

*=with reduced compression ferrule

Kegelrückschlagventil

mit Übergangsnippel SO 50040

Soupape de retenue à siège conique

avec adaptateur mâle SO 50040

Taper seat non-return valve

with male adaptor SO 50040

SO CV 53B40

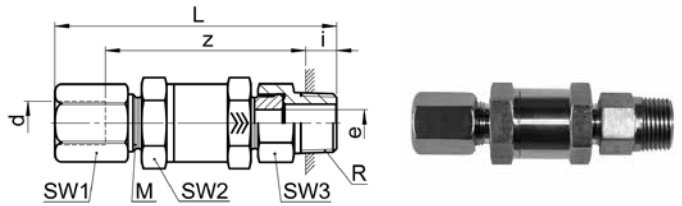

Type -d-R	Mat.-Nr.	bar	M	SW1	SW2	SW3	L	i	z	e	kg/100
Für metrische Rohre R=Rohrgewinde (kegelig)	Pour tubes métriques R=Filetage-gaz BSP (conique)			For metric tubes R=BSP thread (tapered)							
* SO CV 53B40-4-1/8	068.3012.060	200	10x1	12	17	12	56.0	5.0	43.0	3.5	5.000
* SO CV 53B40-4-1/4	068.3012.065	200	10x1	12	17	14	60.0	8.0	44.0	3.5	6.000
* SO CV 53B40-5-1/8	068.3012.082	200	10x1	12	17	12	56.0	5.0	43.0	3.8	5.000
* SO CV 53B40-5-1/4	068.3012.084	200	10x1	12	17	14	60.0	8.0	44.0	3.8	6.000
SO CV 53B40-6-1/8	068.3012.100	200	10x1	12	17	12	56.0	5.0	43.0	3.8	5.300
SO CV 53B40-6-1/4	068.3012.110	200	10x1	12	17	14	60.0	8.0	44.0	3.8	6.300
SO CV 53B40-8-1/8	068.3012.160	200	12x1	14	19	14	62.0	5.0	48.5	5.8	7.300
SO CV 53B40-8-1/4	068.3012.170	200	12x1	14	19	14	66.0	8.0	49.5	5.8	7.800
SO CV 53B40-8-3/8	068.3012.180	160	12x1	14	19	17	66.0	8.0	49.5	5.8	9.000
SO CV 53B40-8-1/2	068.3012.185	160	12x1	14	19	22	70.0	10.0	51.5	5.8	10.000
SO CV 53B40-10-1/4	068.3012.270	160	14x1	17	22	17	76.0	8.0	56.5	7.5	11.000
SO CV 53B40-10-3/8	068.3012.280	160	14x1	17	22	17	76.0	8.0	56.5	7.5	12.000
SO CV 53B40-10-1/2	068.3012.285	160	14x1	17	22	22	77.0	10.0	55.5	7.5	14.500
SO CV 53B40-12-1/2	068.3012.400	160	16x1	19	22	22	80.0	10.0	58.5	7.5	15.500
* SO CV 53B40-14-1/2	068.3012.504	100	20x1.5	24	30	24	95.0	10.0	67.5	11.0	26.300
SO CV 53B40-15-1/2	068.3012.534	100	20x1.5	24	30	24	90.0	10.0	67.5	11.0	26.000
SO CV 53B40-15-3/4	068.3012.536	100	20x1.5	24	30	27	90.5	9.5	66.5	11.0	26.500

Für Zollrohre

Pour tubes pouces

For inch tubes

SO CV 53B40-6,35-1/8	068.3012.135	200	10x1	12	17	12	56.0	5.0	38.5	3.8	5.300
SO CV 53B40-6,35-1/4	068.3012.140	200	10x1	12	17	14	60.0	8.0	38.5	3.8	6.300
SO CV 53B40-9,52-1/4	068.3012.230	160	14x1	17	22	17	76.0	8.0	51.0	7.5	11.000
SO CV 53B40-9,52-3/8	068.3012.235	160	14x1	17	22	17	76.0	8.0	51.0	7.5	12.000
SO CV 53B40-9,52-1/2	068.3012.240	160	14x1	17	22	22	77.0	10.0	51.0	7.5	14.500
SO CV 53B40-12,7-1/2	068.3012.434	100	20x1.5	24	30	24	90.0	10.0	58.5	11.0	26.000

Umrechnung für "d" bei Zollrohren:

 6,35 = 1/4
 9,52 = 3/8
 12,7 = 1/2

Conversion de "d" pour tubes en pouces:

 6,35 = 1/4
 9,52 = 3/8
 12,7 = 1/2

Conversion for "d" for inch tubes:

 6,35 = 1/4
 9,52 = 3/8
 12,7 = 1/2

d=Rohrassens-ø

kv=Kenngröße für das Durchflussverhalten (l/min)

L=Mass in montiertem Zustand

*=mit reduziertem Klemmring

d=ø extérieur du tube

kv=facteur d'écoulement (l/min)

L=après montage

*=avec bague de serrage de réduction

d=tube outside diameter

kv=flow factor (l/min)

L=installed length

*=with reduced compression ferrule

Kugelhahn

mit Innengewinde

Robinet à bille

avec taraudage femelle

Ball valve

with female thread

SO BV 58A00

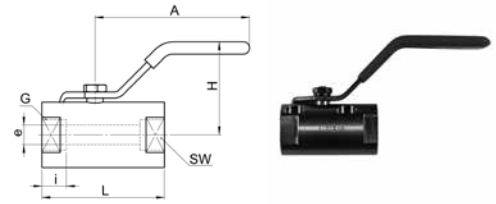

Type -G	Mat.-Nr.	bar	SW	L	A	H	i	e	kv	kg/100
G=Rohrgewinde (zylindrisch)	G=Filetage-gaz BSP (cylindrique)	G=BSP thread (parallel)								
SO BV 58A00-1/4	068.8041.040	55	26	59.5	115.0	54.0	10.0	8.0	70.0	34.000
SO BV 58A00-3/8	068.8041.060	55	27	59.5	115.0	60.0	12.0	9.6	100.0	33.500
SO BV 58A00-1/2	068.8041.080	55	27	59.5	105.0	60.0	12.0	9.6	100.0	31.000
SO BV 58A00-3/4	068.8041.120	55	34	67.0	105.0	64.0	14.0	12.5	100.0	45.400
SO BV 58A00-1	068.8041.160	55	41	76.0	105.0	64.0	14.0	16.5	100.0	68.000

Spezifikationen

Betriebsdruck (PN): 55 bar
Temperatur: -40°C/+200°C
Sicherheitsfaktor: 1.5-fach

Spécifications

Pression de service (PN): 55 bar
Température: -40°C/+200°C
Facteur de sécurité: 1.5 fois

Specifications

Working pressure (PN): 55 bar
Temperature: -40°C/+200°C
Safety factor: 1.5 times

Merkmale

Ventilkörper, Kugel, Spindel aus 1.4436 (AISI 316)
Griff aus 1.4301 (AISI 304) mit PVC-Überzug
Dichtungen aus PTFE

Caractéristiques

Corps, bille, pointeau en 1.4436 (AISI 316)
Manette en 1.4301 (AISI 304) avec couche en PVC
Joints en PTFE

Characteristics

Valve body, ball, spindle of 1.4436 (AISI 316)
Handle of 1.4301 (AISI 304) with PVC cover
Seals of PTFE

Dienstleistungsoptionen auf Anfrage

Options de service sur demande

Optional services on request

Sechskant Kugelhahn

Robinet à bille hexagonal

Hexagon ball valve

SO BV 58D00

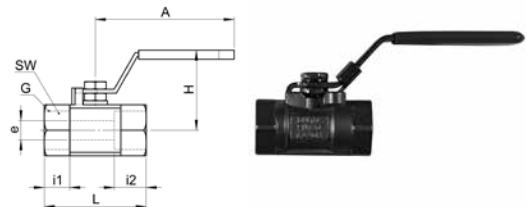

Type -G	Mat.-Nr.	bar	SW	L	A	H	i1	i2	e	kg/100
G=Rohrgewinde (zylindrisch)	G=Filetage-gaz BSP (cylindrique)	G=BSP thread (parallel)								
SO BV 58D00-1/4	068.8061.040	90	28	58.5	102.0	46.0	14.0	15.5	9.2	32.000
SO BV 58D00-3/8	068.8061.060	90	28	58.5	102.0	46.0	15.0	15.0	9.2	32.000
SO BV 58D00-1/2	068.8061.080	90	28	66.0	97.0	54.0	20.0	17.5	9.2	27.500
SO BV 58D00-3/4	068.8061.120	90	34	70.0	98.0	56.0	21.0	19.0	12.5	36.000
SO BV 58D00-1	068.8061.160	90	39	80.0	104.0	63.0	24.0	20.0	15.5	63.000

Spezifikationen

Betriebsdruck (PN): 90 bar
Temperatur: -20°C/+200°C
Sicherheitsfaktor: 1.5-fach

Spécifications

Pression de service (PN): 90 bar
Température: -20°C/+200°C
Facteur de sécurité: 1.5 fois

Specifications

Working pressure (PN): 90 bar
Temperature: -20°C/+200°C
Safety factor: 1.5 times

Merkmale

Ventilkörper, Kugel, Spindel aus 1.4408
Griff aus 1.4301 (AISI 304) mit PVC-Überzug
Dichtungen aus PTFE

Caractéristiques

Corps, bille, pointeau en 1.4408
Manette en 1.4301 (AISI 304) avec couche en PVC
Joints en PTFE

Characteristics

Valve body, ball, spindle of 1.4408
Handle of 1.4301 (AISI 304) with PVC cover
Seals of PTFE

Dienstleistungsoptionen auf Anfrage

Options de service sur demande

Optional services on request

e=kleinste Bohrung
kv=Kenngröße für das Durchflussverhalten (l/min)
L=Mass in montiertem Zustand

e=ø-min. de passage
kv=facteur d'écoulement (l/min)
L=après montage

e=minimum bore
kv=flow factor (l/min)
L=installed length

Kugelhahn

Robinet à bille

Ball valve

SO BV 58D21

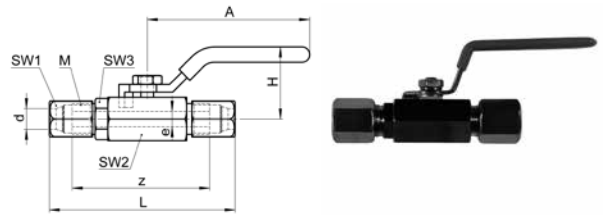

Type -d	Mat.-Nr.	bar	M	SW1	SW2	SW3	L	A	H	z	e	kv	kg/100
* SO BV 58D21-6	068.8000.060	64	12x1	14	17	14	72.0	62.0	30.0	55.5	4.5	30.0	5.800
SO BV 58D21-8	068.8000.080	64	12x1	14	17	14	72.0	62.0	30.0	54.0	5.0	30.0	5.600
* SO BV 58D21-10	068.8000.100	64	16x1	19	21	17	85.0	85.0	40.0	60.0	7.5	60.0	10.000
SO BV 58D21-12	068.8000.120	64	16x1	19	21	17	85.0	85.0	40.0	60.0	7.5	60.0	9.800

Spezifikationen

Betriebsdruck: 64 bar
 Temperatur: -40°C/+180°C
 Sicherheitsfaktor: 1.5-fach

Spécifications

Pression de service: 64 bar
 Température: -40°C/+180°C
 Facteur de sécurité: 1.5 fois

Specifications

Working pressure: 64 bar
 Temperature: -40°C/+180°C
 Safety factor: 1.5 times

Merkmale

Kompakter Kugelhahn mit beidseitigen Rohranschlüssen für die Verwendung in Heizungs-, Industrie- und Chemieanlagen.
 Ventilkörper, Kugel und Spindel: Edelstahl 1.4436 (AISI 316)
 Griff: Edelstahl 1.4301 (AISI 304) mit PVC-Überzug
 Dichtungen: PTFE
 Rohranschlüsse: Edelstahl 1.4571 (AISI 316 Ti)

Caractéristiques

Robinet à bille compact avec raccordement SERTO pour les applications générales dans les installations de chauffage, de l'industrie et de la chimie.
 Corps, bille et pointeau: acier inox 1.4436 (AISI 316)
 Manette: acier inox 1.4301 (AISI 304) avec couche en PVC
 Joints: PTFE
 Raccordement: acier inox 1.4571 (AISI 316 Ti)

Characteristics

Compact ball valve with tube connection both ends for general application in heating, industry and chemical installations.
 Valve body, ball and spindle: stainless steel 1.4436 (AISI 316)
 Handle: stainless steel 1.4301 (AISI 304) with cover of PVC
 Seals: PTFE
 Tube connections: stainless steel 1.4571 (AISI 316 Ti)

Dienstleistungsoptionen auf Anfrage

Options de service sur demande

Optional services on request

Kugelhahn

mit Übergangsmuffe SO 50030

Robinet à bille

avec adaptateur femelle SO 50030

Ball valve

with female adaptor SO 50030

SO BV 58D30

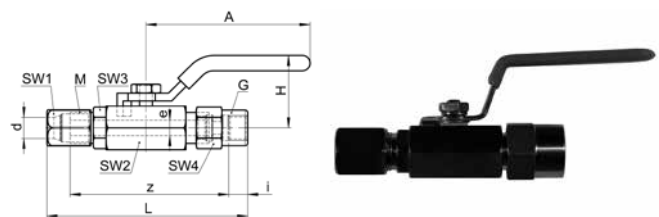

Type -d-G	Mat.-Nr.	bar	M	SW1	SW2	SW3	SW4	L	A	H	i	z	e	kv	kg/100
G=Rohrgewinde (zylindrisch)															
* SO BV 58D30-6-1/8	068.8301.100	64	12x1	14	17	14	17	76.0	62.0	30.0	10.0	58.0	4.5	30.0	7.100
* SO BV 58D30-6-1/4	068.8301.110	64	12x1	14	17	14	17	77.0	62.0	30.0	11.0	58.0	4.5	30.0	6.600
SO BV 58D30-8-1/8	068.8301.160	64	12x1	14	17	14	17	76.0	62.0	30.0	10.0	57.0	5.0	30.0	7.200
SO BV 58D30-8-1/4	068.8301.170	64	12x1	14	17	14	17	77.0	62.0	30.0	11.0	57.0	5.0	30.0	6.700
* SO BV 58D30-10-3/8	068.8301.280	64	16x1	19	21	17	22	86.5	85.0	40.0	12.0	62.0	7.5	60.0	11.500
SO BV 58D30-12-3/8	068.8301.390	64	16x1	19	21	17	22	86.5	85.0	40.0	12.0	62.0	7.5	60.0	11.300

Dienstleistungsoptionen auf Anfrage

Options de service sur demande

Optional services on request

d=Rohraussen-ø
 e=kleinste Bohrung
 kv=Kenngröße für das Durchflussverhalten (l/min)
 L=Mass in montiertem Zustand
 *=mit reduziertem Klemmring

d=ø extérieur du tube
 e=ø-min. de passage
 kv=facteur d'écoulement (l/min)
 L=après montage
 *=avec bague de serrage de réduction

d=tube outside diameter
 e=minimum bore
 kv=flow factor (l/min)
 L=installed length
 *=with reduced compression ferrule

Kugelhahn

mit Übergangsnippel SO 50040

Robinet à bille

avec adaptateur mâle SO 50040

Ball valve

with male adaptor SO 50040

SO BV 58D40

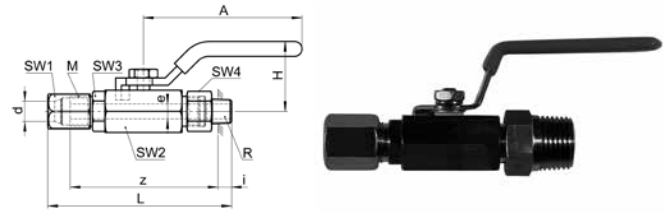

Type -d-R	Mat.-Nr.	bar	M	SW1	SW2	SW3	SW4	L	A	H	z	e	kv	kg/100
R=Rohrgewinde (kegelig)				R=Filetage-gaz BSP (conique)					R=BSP thread (tapered)					
* SO BV 58D40-6-1/8	068.8401.100	64	12x1	14	17	14	14	73.0	62.0	30.0	58.0	4.5	30.0	5.600
* SO BV 58D40-6-1/4	068.8401.110	64	12x1	14	17	14	14	77.0	62.0	30.0	59.0	4.5	30.0	6.000
SO BV 58D40-8-1/8	068.8401.160	64	12x1	14	17	14	14	73.0	62.0	30.0	57.5	5.0	30.0	5.500
SO BV 58D40-8-1/4	068.8401.170	64	12x1	14	17	14	14	77.5	62.0	30.0	58.5	5.0	30.0	6.000
* SO BV 58D40-10-1/4	068.8401.270	64	16x1	19	21	17	19	87.0	85.0	40.0	64.5	7.5	60.0	9.600
* SO BV 58D40-10-3/8	068.8401.280	64	16x1	19	21	17	19	85.5	85.0	40.0	63.0	7.5	60.0	9.800
* SO BV 58D40-10-1/2	068.8401.285	64	16x1	19	21	17	22	89.5	85.0	40.0	64.0	7.5	60.0	12.500
SO BV 58D40-12-1/4	068.8401.380	64	16x1	19	21	17	19	87.0	85.0	40.0	64.5	7.5	60.0	9.600
SO BV 58D40-12-3/8	068.8401.390	64	16x1	19	21	17	19	87.5	85.0	40.0	65.0	7.5	60.0	9.800
SO BV 58D40-12-1/2	068.8401.400	64	16x1	19	21	17	22	89.5	85.0	40.0	64.0	7.5	60.0	12.500

Dienstleistungsoptionen auf Anfrage

Options de service sur demande

Optional services on request

d=Rohraussen-ø
 e=kleinste Bohrung
 kv=Kenngröße für das Durchflussverhalten (l/min)
 L=Mass in montiertem Zustand
 *=mit reduziertem Klemmring

d=ø extérieur du tube
 e=ø-min. de passage
 kv=facteur d'écoulement (l/min)
 L=après montage
 *=avec bague de serrage de réduction

d=tube outside diameter
 e=minimum bore
 kv=flow factor (l/min)
 L=installed length
 *=with reduced compression ferrule

Nadelventil

mit Innengewinde

Robinet à pointeau

avec taraudage femelle

Needle valve

with female thread

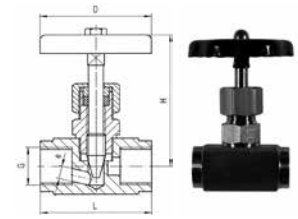

SO NV 51B00

Type -G	Mat.-Nr.	bar	L	D	H	e	kv	kg/100
G=Rohrgewinde (zylindrisch)	G=Filetage-gaz BSP (cylindrique)	G=BSP thread (parallel)						
SO NV 51B00- $\frac{3}{8}$	068.1010.060	200	55.0	60.0	93.0	6.0	10.0	32.000
SO NV 51B00- $\frac{1}{2}$	068.1010.080	200	60.0	60.0	96.0	7.0	12.0	41.500
SO NV 51B00- $\frac{3}{4}$	068.1010.120	200	75.0	70.0	117.0	8.0	29.0	75.300
SO NV 51B00-1	068.1010.160	200	100.0	90.0	138.0	12.0	32.0	154.000

Spezifikationen

Betriebsdruck: 200 bar
Temperatur: -40°C/+200°C
Sicherheitsfaktor: 1.5-fach

Merkmale

Ventilkörper, Spindel, Mutter: Edelstahl 1.4571
Handrad: Stahlblech lackiert
Stopfbuchse: PTFE

Dienstleistungsoptionen auf Anfrage

Spécifications

Pression de service: 200 bar
Température: -40°C/+200°C
Facteur de sécurité: 1.5 fois

Caractéristiques

Corps, pointeau, écrou: acier inox 1.4571
Volant: acier laqué
Presse-étoupe: PTFE

Options de service sur demande

Specifications

Working pressure: 200 bar
Temperature: -40°C/+200°C
Safety factor: 1.5 times

Characteristics

Valve body, spindle, nut: stainless steel 1.4571
Handwheel: lacquered sheet metal
Seals: PTFE

Optional services on request

Nadelventil

Robinet à pointeau

Needle valve

12

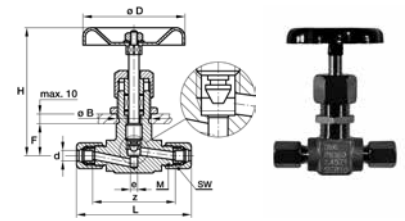

SO NV 51B21

Type - d	Mat.-Nr.	bar	M	SW	L	B	D	F	H	z	e	kv	kg/100
Für metrische Rohre	Pour tubes métriques				For metric tubes								
* SO NV 51B21-4	068.1500.040	160	10x1	12	72.0	22.5	70.0	19.0	88.0	57.0	4.0	3.5	42.000
* SO NV 51B21-5	068.1500.050	160	10x1	12	72.0	22.5	70.0	19.0	88.0	57.0	4.0	3.5	42.000
SO NV 51B21-6	068.1500.060	160	10x1	12	72.0	22.5	70.0	19.0	88.0	57.0	4.0	4.0	42.000
SO NV 51B21-8	068.1500.080	160	12x1	14	76.0	22.5	70.0	19.0	88.0	60.0	6.0	7.1	44.000
SO NV 51B21-10	068.1500.100	160	14x1	17	80.0	22.5	70.0	19.0	88.0	60.0	6.0	7.5	46.000
SO NV 51B21-12	068.1500.120	160	16x1	19	82.0	22.5	70.0	19.0	88.0	57.0	6.0	8.5	47.000
SO NV 51B21-15	068.1500.150	100	20x1.5	24	89.0	22.5	70.0	19.0	88.0	62.0	6.0	8.5	50.000
Für Zollrohre	Pour tubes pouces				For inch tubes								
SO NV 51B21-6,35	068.1500.063	160	10x1	12	72.0	22.5	70.0	19.0	88.0	57.0	4.0	4.0	42.000
SO NV 51B21-9,52	068.1500.095	160	14x1	17	80.0	22.5	70.0	19.0	88.0	60.0	6.0	7.5	46.000

Umrechnung für "d" bei Zollrohren:
 6,35 = 1/4
 9,52 = 3/8

Conversion de "d" pour tubes en pouces:
 6,35 = 1/4
 9,52 = 3/8

Conversion for "d" for inch tubes:
 6,35 = 1/4
 9,52 = 3/8

Spezifikationen

Betriebsdruck: 160 bar
 Temperatur: -40°C/+200°C
 Sicherheitsfaktor: 1.5-fach

Spécifications

Pression de service: 160 bar
 Température: -40°C/+200°C
 Facteur de sécurité: 1.5 fois

Specifications

Working pressure: 160 bar
 Temperature: -40°C/+200°C
 Safety factor: 1.5 times

Merkmale

Ventilkörper und Spindel: Edelstahl 1.4571
 Kontermutter: Edelstahl 1.4301
 Handrad: Stahlblech lackiert
 Stopfbuchse: Graphit

Caractéristiques

Corps et pointeau: acier inox 1.4571
 Contre-écrou: acier inox 1.4301
 Volant: acier laqué
 Presse-étoupe: graphite

Characteristics

Valve body and spindle: stainless steel 1.4571
 Counter-nut: stainless steel 1.4301
 Handwheel: lacquered sheet metal
 Seals: graphite

Dienstleistungsoptionen auf Anfrage

Options de service sur demande

Optional services on request

d=Rohrussen-ø
 e=kleinste Bohrung
 kv=Kenngröße für das Durchflussverhalten (l/min)
 L=Mass in montiertem Zustand
 *=mit reduziertem Klemmring

d=ø extérieur du tube
 e=ø-min. de passage
 kv=facteur d'écoulement (l/min)
 L=après montage
 *=avec bague de serrage de réduction

d=tube outside diameter
 e=minimum bore
 kv=flow factor (l/min)
 L=installed length
 *=with reduced compression ferrule

2-Weg Hochdruckkugelhahn

Robinet à bille droite pour haute pression

2-way high pressure ball valve

HKM-G
SOL BV 58A21

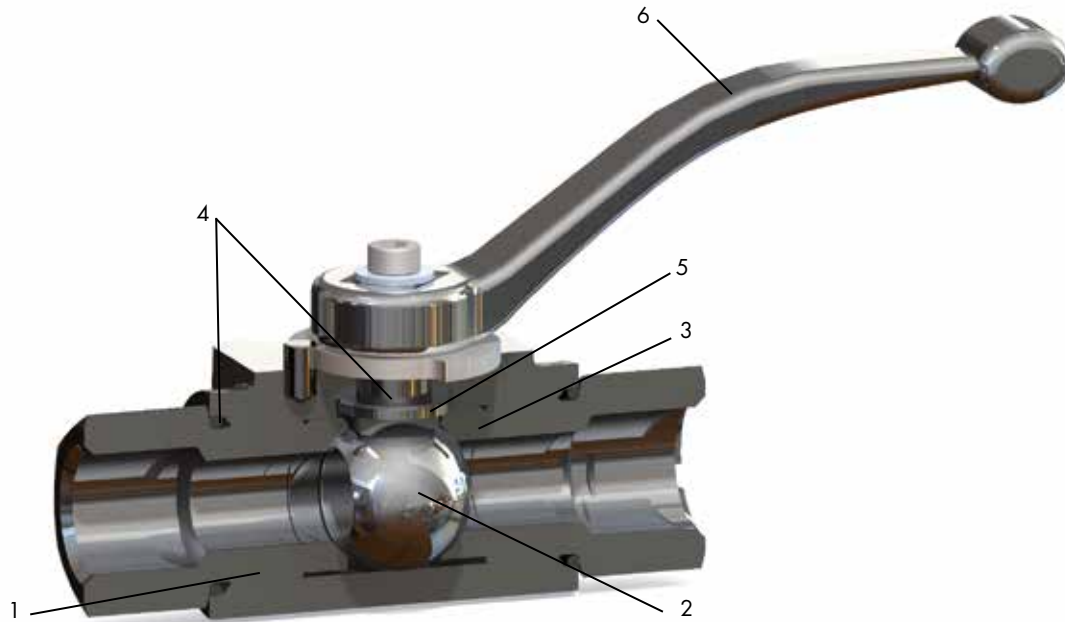

Nr. No. No.	Bezeichnung Désignation Description	Material Matériau Material	Nr. No. No.	Bezeichnung Désignation Description	Material Matériau Material	Nr. No. No.	Bezeichnung Désignation Description	Material Matériau Material
1	Ventilkörper Corps cône de soupape Valve body	1.4571	3*	Dichtschale Enveloppe d'étanchéité Sealing bush	POM	5	Spindelflachdichtung Joint plat de tige Stem sealing	PTFE
2	Kugel Bille Ball	1.4571	4	Dichtung Joint Seal	FKM	6	Hebel Levier Handle	Druckguss Fonte inj. Die casting

Spezifikationen

Betriebsdruck (PN): 400 Bar
 Temperatur: -40°C bis +180°C
 Sicherheitsfaktor: 1.1-fach

Merkmale

- Funktion: Absperrhahn
- Einsatz: durch die Verwendung von rost- und säurebeständigen Edelstählen grösste Einsatzmöglichkeit in allen Industrien
- Besonderes: durch Vollstromquerschnitte keine Druckverluste; leichte Schaltbarkeit auch unter hohem Druck; durch auswechselbare Dichtungen lange Lebensdauer

* Optionen

- Nr. 3 - Dichtschale: PEEK

Spécifications

Pression de service (PN): 400 bar
 Température: -40°C à +180°C
 Facteur de sécurité: 1.1 fois

Caractéristiques

- Fonction : robinet d'arrêt
- Utilisation: grâce à l'emploi d'aciers inoxydables résistants à la rouille et aux acides conçu pour un maximum d'applications dans tous les secteurs
- Particularité: pas de pertes de pression grâce au passage intégral ; manœuvre facile même sous pression; longue durée de vie du produit grâce à la possibilité de changer les joints

* Options

- No. 3 - Enveloppe d'étanchéité: PEEK

Specifications

Working pressure (PN): 400 bar
 Temperature: -40°C to +180°C
 Safety factor: 1.1 times

Characteristics

- Function: shut-off valve
- Uses: large range of industrial applications due to use of corrosion and acid-resistant stainless steels
- Special features: no pressure loss due to full-flow cross-sections; easy switching even under high pressure; long service life thanks to replaceable seals

* Options

- No. 3 - Sealing bush: PEEK

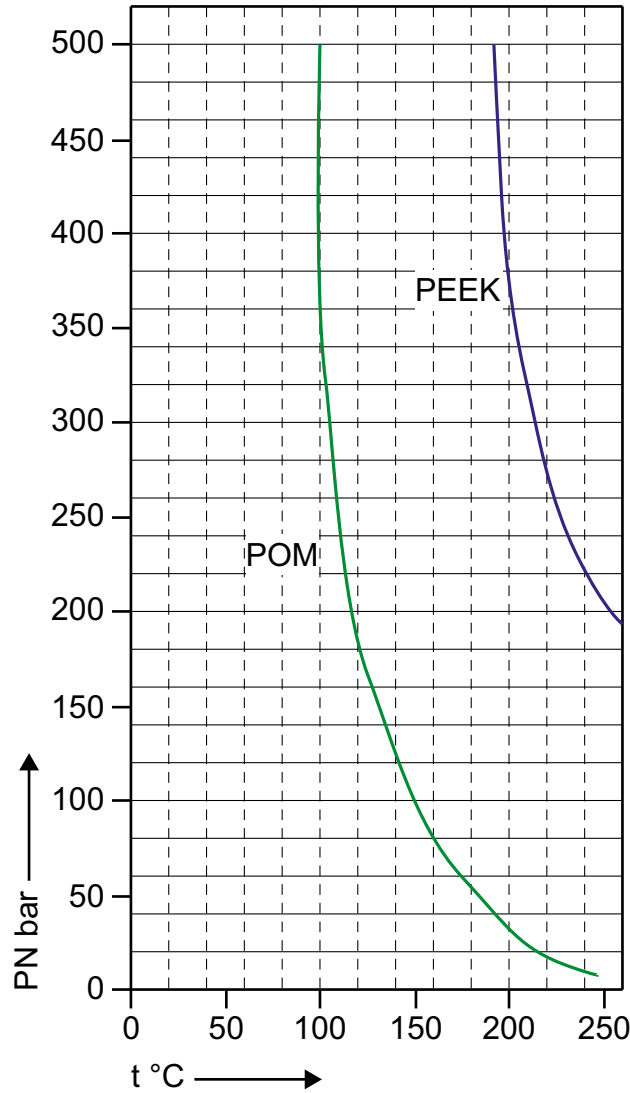

Achtung

Hochdruckkugelhähne, die mit Dichtschalen aus PEEK geliefert werden sollen, müssen bei der Bestellung klar mit "PEEK" nach der Materialnummer gekennzeichnet werden.

Attention

Robinets, qui doivent être fournis avec douille d'étanchéité en PEEK sont à référencer dans la commande avec la mention "PEEK" après le numéro de référence.

Attention

High pressure ball valves which are to be supplied with sealing bush in PEEK must be clearly identifiable in the order with the extension "PEEK" after the material number.

Hochdruck-Kugelhähne PN 500

beidseitig Innengewinde nach ISO 228/1

Robinet à bille pour haute pression

avec filetage femelle BSP selon DIN-ISO 228/1

High pressure ball valves PN 500

double-sided female thread to ISO 228/1

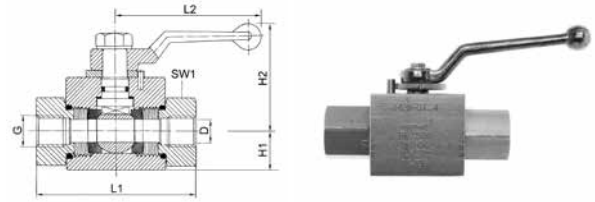

HKM-G

Type -G	Mat.-Nr.	PN	G	SW1	D	L1	L2	H1	H2	g/Stk
G=Rohrgewinde (zylindrisch)			G=Filetage-gaz BSP (cylindrique)				G=BSP thread (parallel)			
HKM-G 1.8	808.8100.020	500	1/8	22	5.0	69.0	115.0	13.5	70.0	410
HKM-G 1.4	808.8100.040	500	1/4	22	6.0	69.0	115.0	13.5	70.0	400
HKM-G 3.8	808.8100.060	500	3/8	27	10.0	72.0	115.0	17.5	71.0	540
HKM-G 1.2	808.8100.080	500	1/2	30	13.0	83.0	115.0	19.0	71.0	650
HKM-G 3.4	808.8100.120	315	3/4	41	20.0	95.0	161.0	24.5	79.0	1500
HKM-G 1.1	808.8100.160	315	1	50	25.0	113.0	161.0	29.5	82.0	2200

Dienstleistungsoptionen auf Anfrage

Options de service sur demande

Optional services on request

2-Weg Hochdruckkugelhahn SOL

Robinet à bille pour haute pression

2-way high pressure ball valve SOL

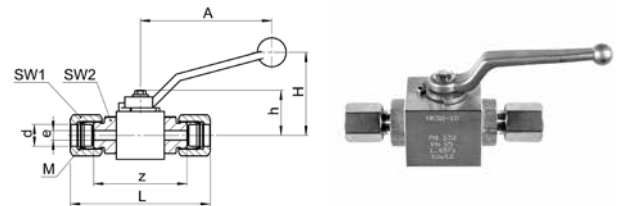

SOL BV 58A21

Type -d	Mat.-Nr.	bar	M	SW1	SW2	L	A	H	z	e	kv	kg/100
SOL BV 58A21-6	088.8102.060	400	10x1	14	22	94.5	115.0	82.0	74.5	4.5	30.0	43.300
SOL BV 58A21-8	088.8102.080	330	12x1	17	22	97.5	115.0	82.0	76.5	6.0	30.0	45.000
SOL BV 58A21-10	088.8102.100	330	14x1	19	22	101.5	115.0	82.0	76.5	6.0	60.0	46.500
SOL BV 58A21-12	088.8102.120	330	16x1	22	22	103.5	115.0	82.0	76.5	6.0	60.0	49.200
SOL BV 58A21-15	088.8102.150	250	20x1.5	27	27	115.5	115.0	86.0	85.5	10.0	60.0	69.700
SOL BV 58A21-16	088.8102.160	200	24x1.5	30	27	122.8	115.0	86.0	85.5	10.0	60.0	74.800
SOL BV 58A21-18	088.8102.180	200	24x1.5	30	27	120.0	115.0	86.0	85.8	10.0	60.0	73.000

Dienstleistungsoptionen auf Anfrage

Options de service sur demande

Optional services on request

d=Rohrassen-ø

e=kleinste Bohrung

kv=Kenngröße für das Durchflussverhalten (l/min)

L=Mass in montiertem Zustand

H=Ventil geöffnet

d=ø extérieur du tube

e=ø-min. de passage

kv=facteur d'écoulement (l/min)

L=après montage

H=vanne ouvert

d=tube outside diameter

e=minimum bore

kv=flow factor (l/min)

L=installed length

H=valve opened

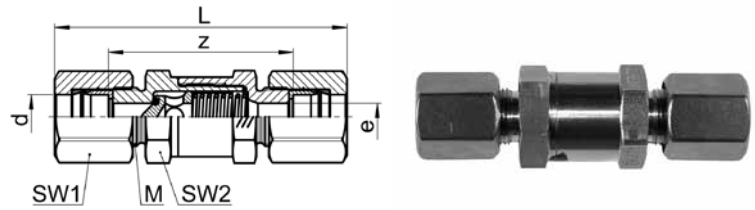
Kegelrückschlagventil
Soupape de retenue à siège conique
Taper seat non-return valve
SOL CV 53B21

Type -d	Mat.-Nr.	bar	M	SW1	SW2	L	z	e	kg/100
Für metrische Rohre	Pour tubes métriques			For metric tubes					
SOL CV 53B21-6	088.3010.060	400	10x1	12	17	58.5	38.5	3.8	6.900
SOL CV 53B21-8	088.3010.080	330	12x1	14	19	64.5	44.0	5.8	10.000
SOL CV 53B21-10	088.3010.100	330	14x1	17	22	76.0	51.0	7.5	15.000
SOL CV 53B21-12	088.3010.120	330	16x1	19	22	76.0	51.0	7.5	15.000
SOL CV 53B21-15	088.3010.150	250	20x1.5	24	30	89.0	58.5	11.0	32.000

Für Zollrohre	Pour tubes pouces			For inch tubes					
SOL CV 53B21-6,35	088.3010.063	400	10x1	12	17	58.5	38.5	3.8	6.900
SOL CV 53B21-9,52	088.3010.095	330	14x1	17	22	64.5	51.0	7.5	15.000
SOL CV 53B21-12,7	088.3010.127	250	20x1.5	24	30	89.0	58.5	11.0	31.000

Umrechnung für "d" bei Zollrohren:

6,35 = 1/4

9,52 = 3/8

12,7 = 1/2

Conversion de "d" pour tubes en pouces:

6,35 = 1/4

9,52 = 3/8

12,7 = 1/2

Conversion for "d" for inch tubes:

6,35 = 1/4

9,52 = 3/8

12,7 = 1/2

Technische Informationen und Diagramme siehe SO CV 53B21

Informations techniques et diagrammes voir SO CV 53B21

Technical information and diagrams see SO CV 53B21

Kegelrückschlagventil
Soupape de retenue à siège conique
Taper seat non-return valve

SO 6611
SO 6613

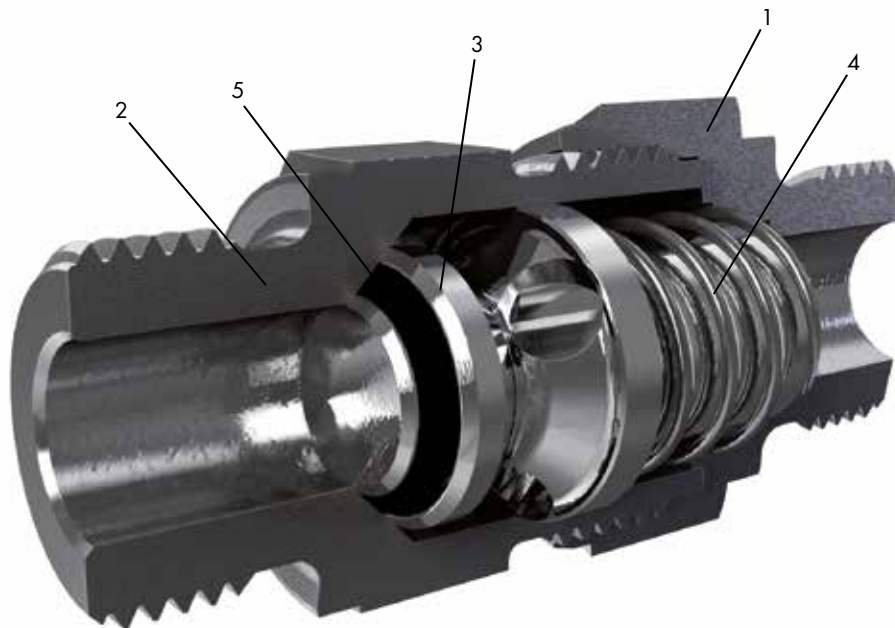

Nr. No. No.	Bezeichnung Désignation Description	Material Matériau Material	Nr. No. No.	Bezeichnung Désignation Description	Material Matériau Material	Nr. No. No.	Bezeichnung Désignation Description	Material Matériau Material
1	Ventilmutter Écrou de soupape Valve nut	1.0718	3	Ventilkegel Cône de soupape Valve cone	1.0718	5*	Dichtung Joint Seal	NBR
2	Ventilkegelführung Guidage cône de soupape Valve cone guide	1.0718	4*	Druckfeder Ressort de compression Compression spring	1.1200 DH			

Spezifikationen

Betriebsdruck (PN): 160 bis 250 bar
 Temperatur: -20°C bis +80°C
 Öffnungsdruck: 1 bar ± 20 %
 Sicherheitsfaktor: 1.5-fach

Merkmale

- Funktion: Rückflussverhinderer

*** Optionen**

- Nr. 4 - Druckfeder: Öffnungsdruck 0.5, 1.5, 2.5 bar ± 20 %
- Nr. 5 - Dichtung: EPDM, FKM

Spécifications

Pression de service (PN): 160 à 250 bar
 Température: -20°C à +80°C
 Pression d'ouverture: 1 bar ± 20 %
 Facteur de sécurité: 1.5 fois

Caractéristiques

- Fonction: clapet anti-retour

*** Options**

- No. 4 - Ressort de compression: pression d'ouverture 0.5, 1.5, 2.5 bar ± 20 %
- No. 5 - Joint: EPDM, FKM

Specifications

Working pressure (PN): 160 to 250 bar
 Temperature: -20°C to +80°C
 Opening pressure: 1 bar ± 20 %
 Safety factor: 1.5 times

Characteristics

- Function: check valve

*** Options**

- No. 4 - Compression spring: opening pressure 0.5, 1.5, 2.5 bar ± 20 %
- No. 5 - Seal: EPDM, FKM

Durchflussdiagramm

Der Druckabfall nimmt mit zunehmendem Durchfluss überproportional zu.

Courbe de débit

La perte de pression augmente disproportionnellement avec plus de débit.

Flow rate

The pressure drop increases disproportionately with increasing flow rate.

SO 6611

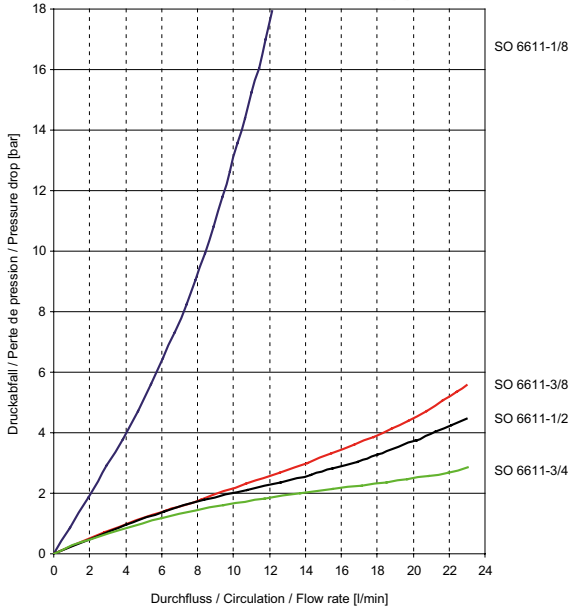

SO 6613

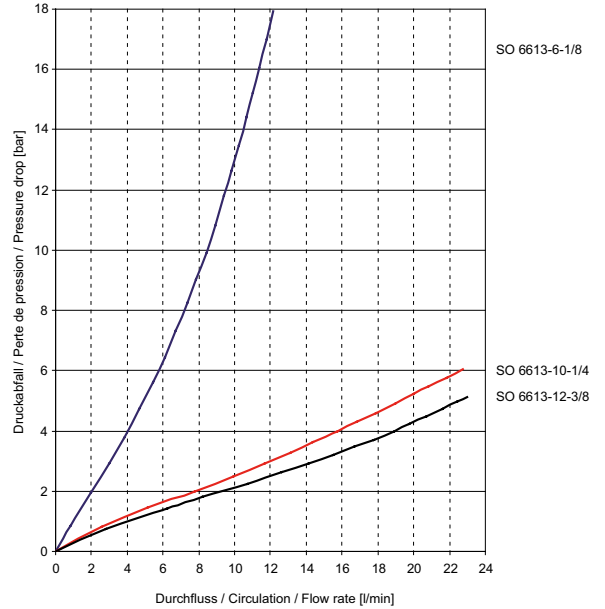

Öffnungsdruckdiagramm

Der Öffnungsdruck bewegt sich im blau skizzierten Bereich. Das Ventil schliesst im rot skizzierten Bereich.

Courbe de pression d'ouverture

La pression d'ouverture se trouve dans la zone indiquée en bleu. La vanne se ferme dans la zone indiquée en rouge.

Opening pressure diagram

The opening pressure ranges within the blue section. The valve closes within the red section.

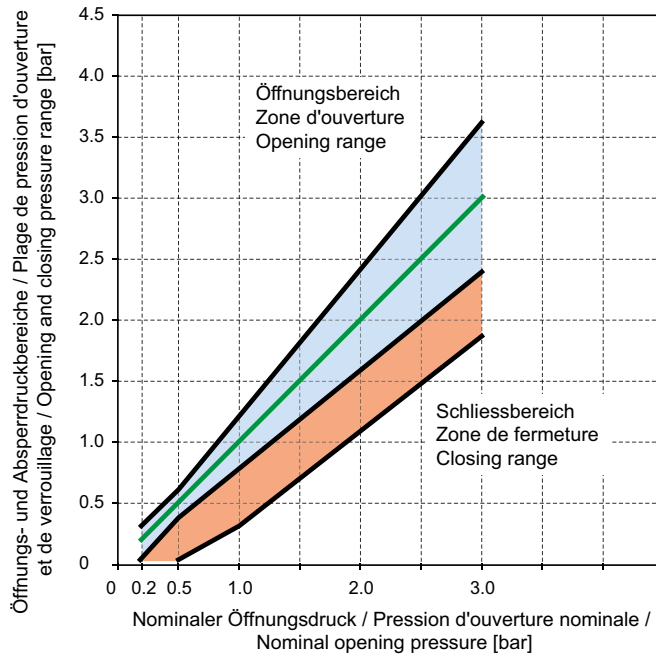

Sonderausführungen

siehe Kapitelübersicht

Exécutions en option

voir aperçu du chapitre

Optional services

see chapter overview

Kegelrückschlagventil

beidseitig mit Einschraubgewinde

Soupape de retenue à siège conique

avec filetage mâle des deux côtés

Taper seat non-return valve

with male adaptor thread at both ends

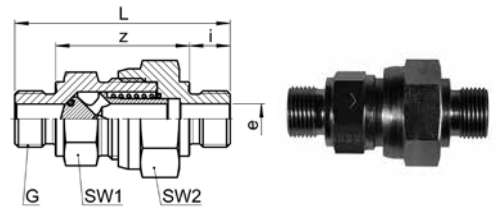
SO 6611

Type -G	Mat.-Nr.	bar	SW1	SW2	L	i	z	e	kg/100
G=Rohrgewinde (zylindrisch)	G=Filetage-gaz BSP (cylindrique)	G=BSP thread (parallel)							
SO 6611-1/8-1/8	228.6110.020	250	14	17	41.0	8.0	25.0	3.8	3.700
SO 6611-3/8-3/8	228.6110.060	200	24	30	64.0	12.0	40.0	8.8	15.800
SO 6611-1/2-1/2	228.6110.080	160	27	30	69.0	14.0	41.0	11.0	18.500
SO 6611-3/4-3/4	228.6110.120	160	41	46	81.0	16.0	49.0	16.0	45.000

Kegelrückschlagventil

mit Einschraubgewinde und Rohranschluss

Soupape de retenue à siège conique

avec filetage mâle et raccord pour tube

Taper seat non-return valve

with male adaptor thread and tube connection

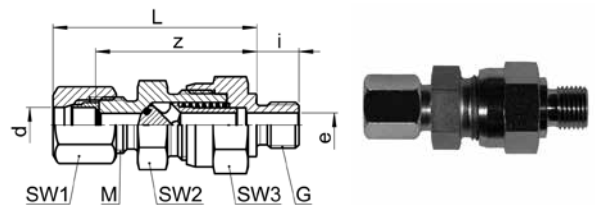
SO 6613

Type -d-G	Mat.-Nr.	bar	M	SW1	SW2	SW3	L	i	z	e	kg/100
G=Rohrgewinde (zylindrisch)	G=Filetage-gaz BSP (cylindrique)	G=BSP thread (parallel)									
SO 6613-6-1/8	228.6130.100	250	12x1.5	14	14	17	44.0	8.0	36.0	3.8	5.000
SO 6613-10-1/4	228.6130.270	200	16x1.5	19	22	24	56.5	12.0	46.0	6.8	13.100
SO 6613-12-3/8	228.6130.390	200	18x1.5	22	24	30	60.0	12.0	48.5	8.8	20.200

Anschraubfuss

Support de fixation

Flange mount

12

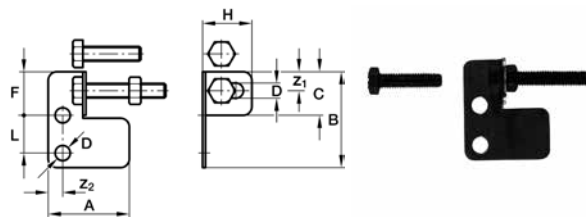
SO 09900

Type	Mat.-Nr.	L	A	B	C	D	F	H	z2	z1	kg/100
SO 09900	028.2750.000	13.0	28.0	33.0	15.0	5.2	15.0	17.0	5.0	6.5	1.660

Werkstoff:

- Fuss: Inox 1.4571

- Schraube/Mutter: Stahl 8.8 schwarz

Matériau:

Support: inox 1.4571

Vis/écrou: acier 8.8 noir

Material:

Mount: inox 1.4571

Screw/nut: steel 8.8 black

Für die Wandmontage sämtlicher Grössen der Ventiltypen SO NV 41A21 / SO NV 41C21 und SO NV 01A21 / SO NV 01C21

Pour le montage mural de tous les dimensions des robinets SO NV 41A21 / SO NV 41C21 et SO NV 01A21 / SO NV 01C21

For wallmounting of all valves, types SO NV 41A21 / SO NV 41C21 and SO NV 01A21 / SO NV 01C21

Ventilschilder (Satz)
Plaques indicatrices (set)
Valve labels (set)

VSD SO NV

Type	Mat.-Nr.
VSD NV 01A/31A/51A-6/8 (RV) colored	065.1000.001
VSD NV 51A-10/12/15 (RV) colored	065.1000.002
VSD NV 01C/51C-6/8 (FRV) colored	065.1000.010
VSD NV 51C-10/12/15 (FRV) colored	065.1000.011
VSD NV 01A+C/31A/51A+C-6/8 (RV/FRV)black	065.1001.080
VSD NV 51A+C-10/12/15 (RV/FRV) black	065.1001.150
VSD SO NV41A Set RV	255.1001.001
VSD SO NV41C Set FRV	255.1001.002
VSD SO NV41A Set grau/RV	255.1101.122
VSD SO NV41C Set grau/FRV	255.1101.222

065.1000.001:

für Regulierventil (RV) MsG/PA/Inox, Grösse 6-8 grün/gelb, blau/rot eloxiert

065.1000.002:

für Regulierventil (RV) Inox, Grösse 10-15 grün/gelb, blau/rot eloxiert

065.1000.010:

für Feinregulierventil (FRV) MsG/PA/Inox, Grösse 6-8 grün/gelb, blau/rot eloxiert

065.1000.011:

für Feinregulierventil (FRV) Inox, Grösse 10-15 grün/gelb, blau/rot eloxiert

065.1001.080:

für Regulier-/Feinregulierventil (RV/FRV) MsG/PA/Inox Grösse 6-8 schwarz eloxiert

065.1001.150:

für Regulier-/Feinregulierventil (RV/FRV) Inox Grösse 10-15 schwarz eloxiert

255.1001.001:

für Regulierventil (RV) MsM/G, rot/blau/grün

255.1001.002:

für Feinregulierventil (FRV) MsM/G, rot/blau/grün

255.1101.122:

für Regulierventil (RV) MsM/G, grau

255.1101.222:

für Feinregulierventil (FRV) MsM/G, grau

065.1000.001:

pour robinet de réglage (RV) laiton G/PA/Inox, tailles 6-8 vert/jaune, bleu/rouge anodisé

065.1000.002:

pour robinet de réglage (RV) Inox, tailles 10-15 vert/jaune, bleu/rouge anodisé

065.1000.010:

pour robinet de réglage fin (FRV) laiton G/PA/Inox, tailles 6-8 vert/jaune, bleu/rouge anodisé

065.1000.011:

pour robinet de réglage fin (FRV) Inox, tailles 10-15 vert/jaune, bleu/rouge anodisé

065.1001.080:

pour robinet de réglage/régl. fin (RV/FRV) laiton G/PA/Inox tailles 6-8 noir anodisé

065.1001.150:

pour robinet de réglage/régl. fin (RV/FRV) Inox tailles 10-15 noir anodisé

255.1001.001:

pour robinet de réglage (RV) laiton M/G, rouge/bleu/vert

255.1001.002:

pour robinet de réglage fin (FRV) laiton M/G, rouge/bleu/vert

255.1101.122:

pour robinet de réglage (RV) laiton M/G, gris

255.1101.222:

pour robinet de réglage fin (FRV) laiton M/G, gris

065.1000.001:

for regulating valve (RV) brass G/PA/Inox, sizes 6-8 green/yellow, blue/red anodized

065.1000.002:

for regulating valve (RV) Inox, sizes 10-15 green/yellow, blue/red anodized

065.1000.010:

for fine regulating valve (FRV) brass G/PA/Inox, sizes 6-8 green/yellow, blue/red anodized

065.1000.011:

for fine regulating valve (FRV) Inox, sizes 10-15 green/yellow, blue/red anodized

065.1001.080:

for regulating-/fine regulating valve (RV/FRV) brass G/PA/Inox sizes 6-8 black anodized

065.1001.150:

for regulating-/fine regulating valve (RV/FRV) Inox sizes 10-15 black anodized

255.1001.001:

for regulating valve (RV) brass M/G, red/blue/green

255.1001.002:

for fine regulating valve (FRV) brass M/G, red/blue/green

255.1101.122:

for regulating valve (RV) brass M/G, grey

255.1101.222:

for fine regulating valve (FRV) brass M/G, grey